

- Cut out each individual foldbook as one piece.
- Fold in half horizontally or vertically with the bolded rectangle on top.
- Paste the three foldbooks inside each of the rectangles on the base panel.

EXAMPLES:

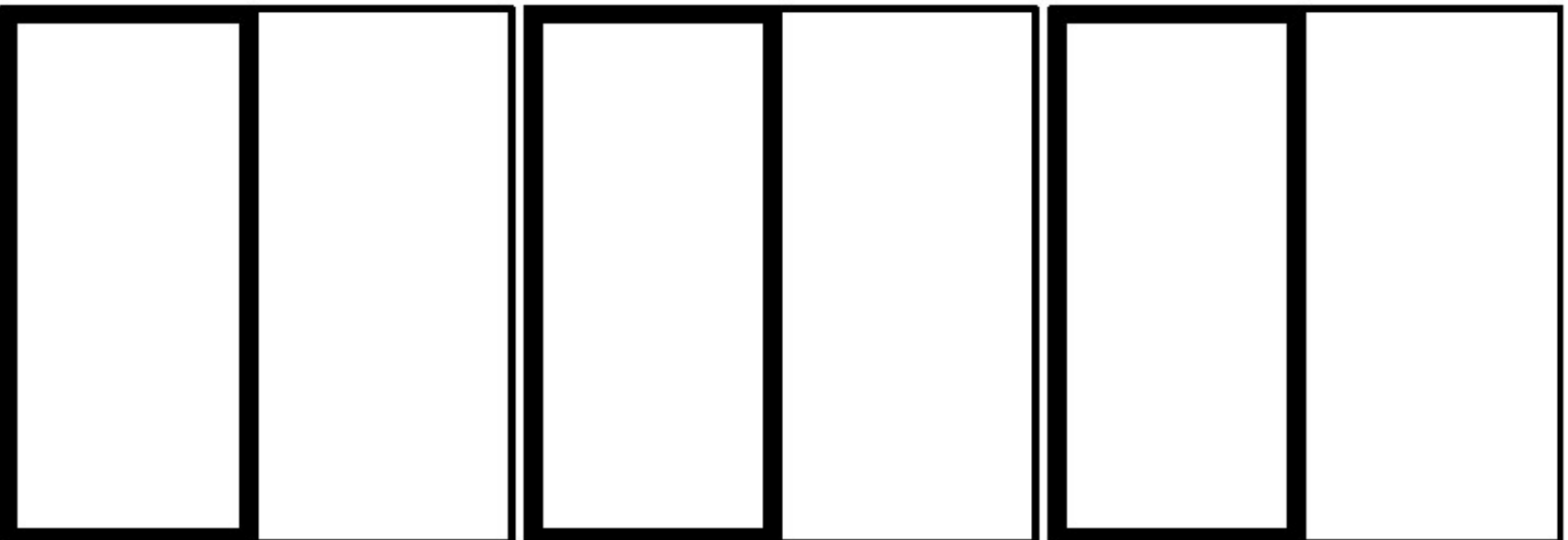

base		
------	--	--

- Cut minibook out as one piece on the solid lines.
- Cut on all solid lines.
- Fold all eight flaps inward on the dotted lines.
- Write title on the top center panel and label flaps as desired.

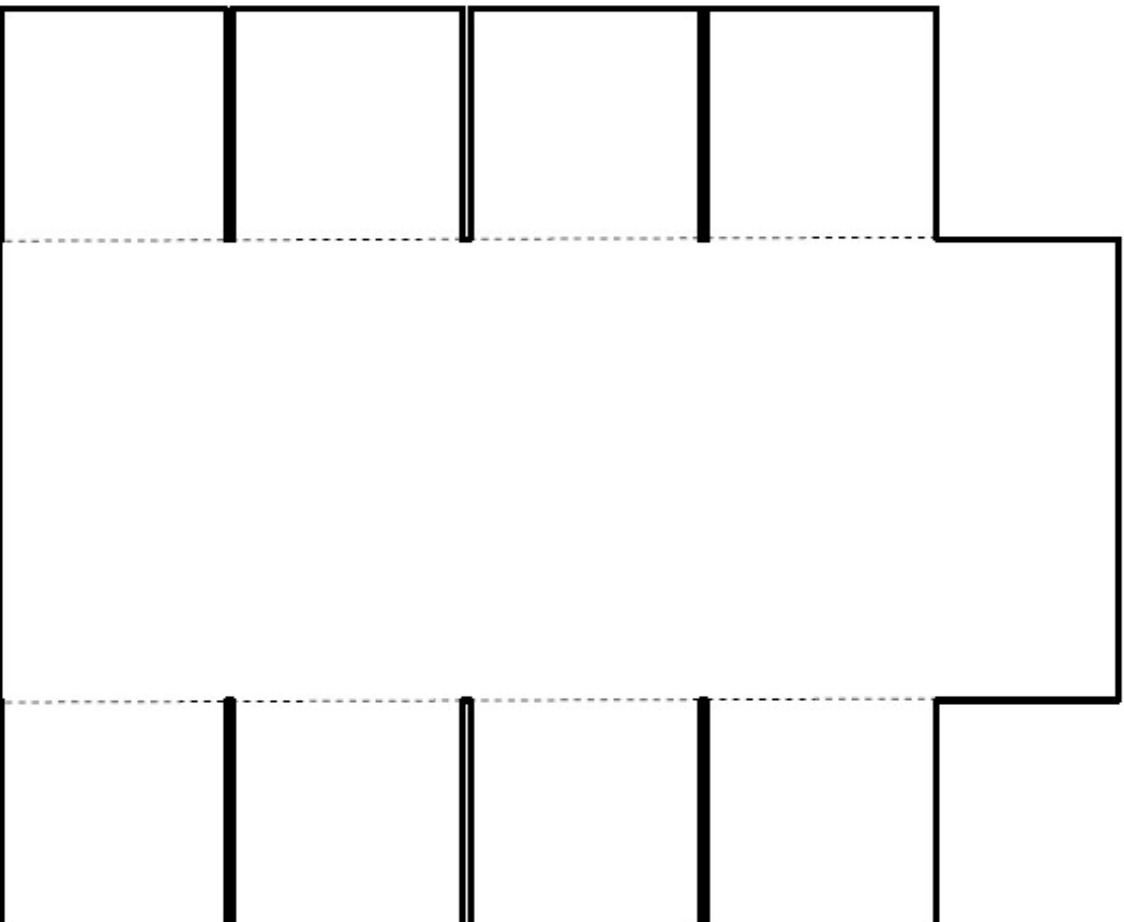

This is for two separate shutterfold minibooks.

- Cut out each minibook on the solid lines.

- Fold flaps inward on the dotted lines.

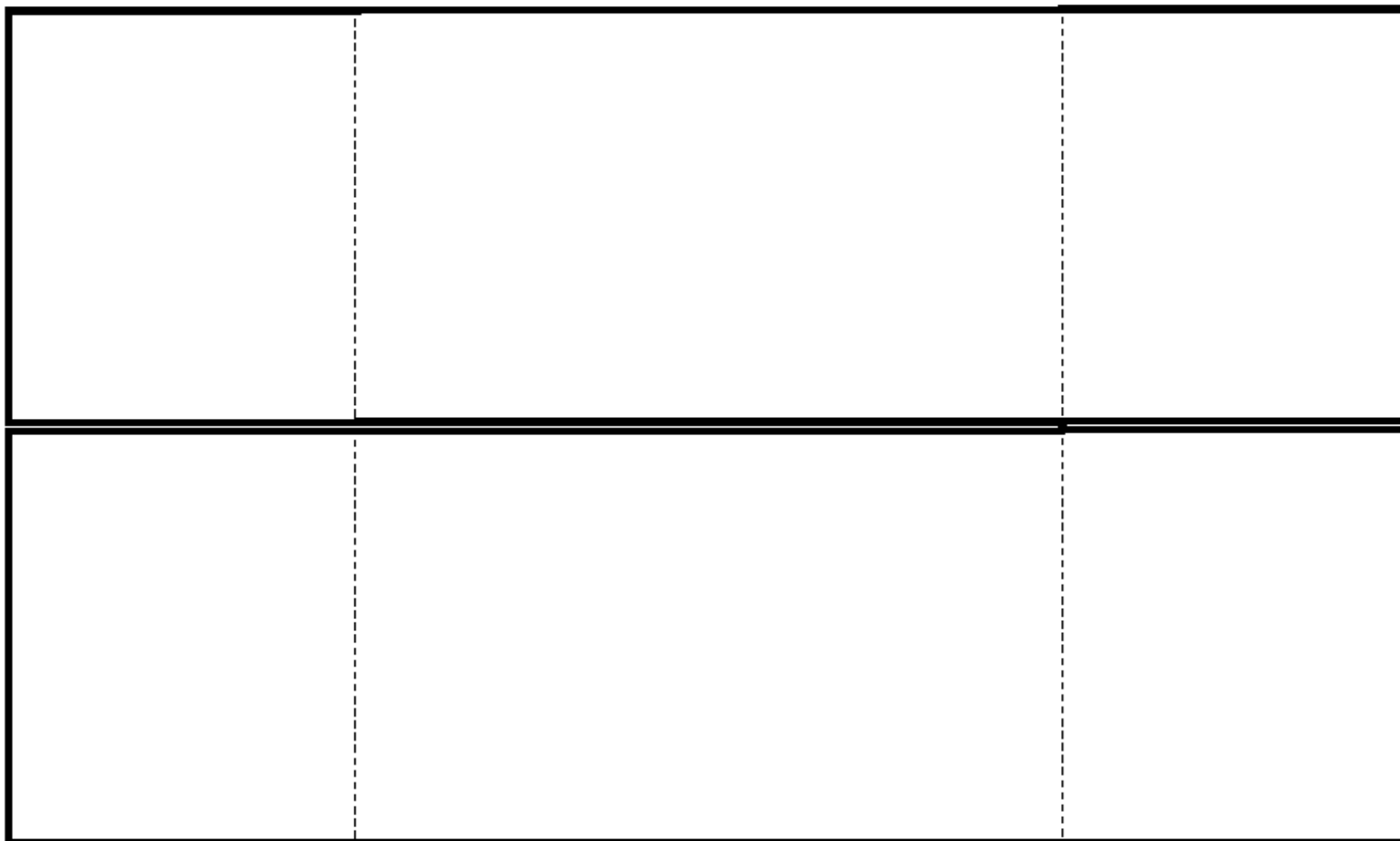

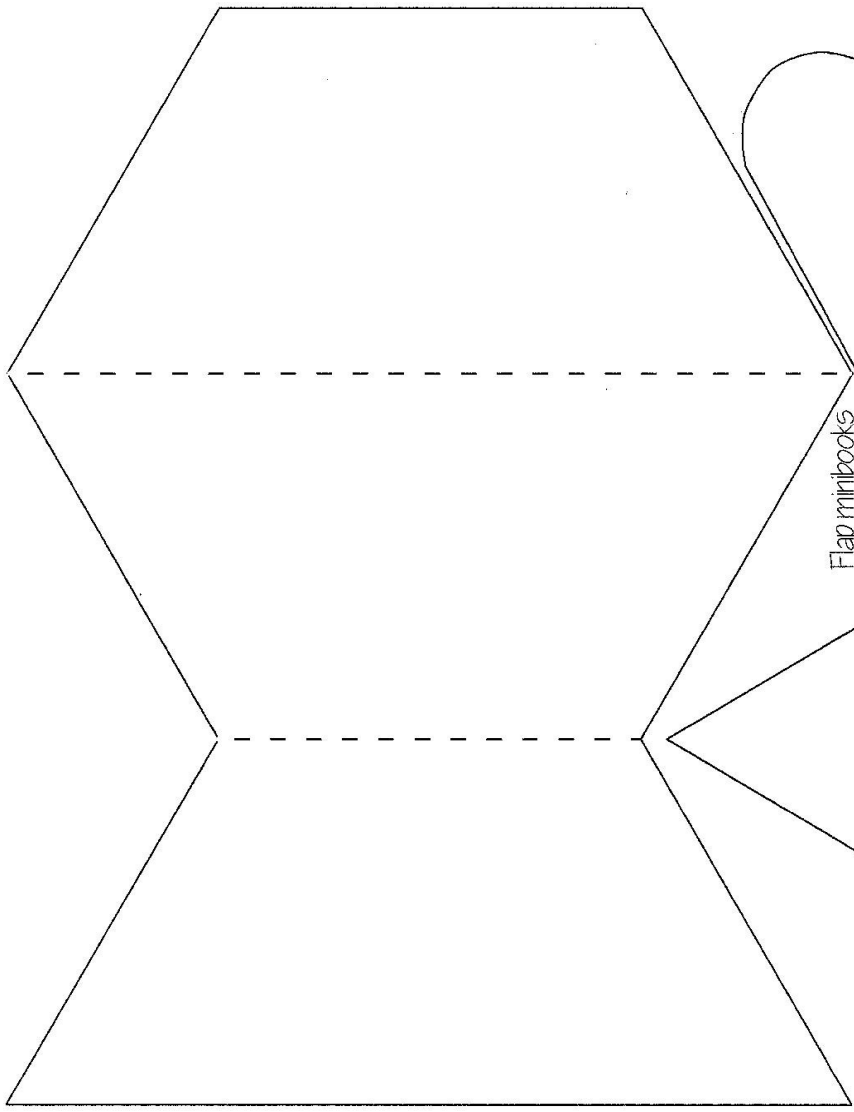

Flap minibooks

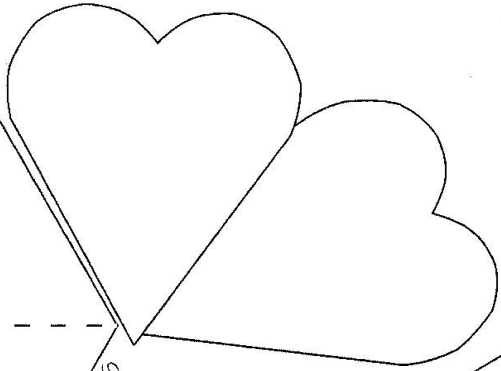

Triangle minibook~
Fold each triangle over

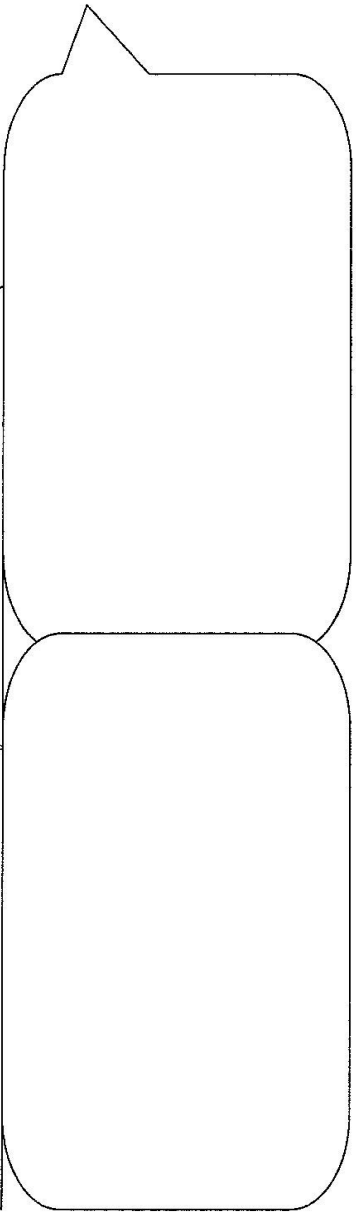
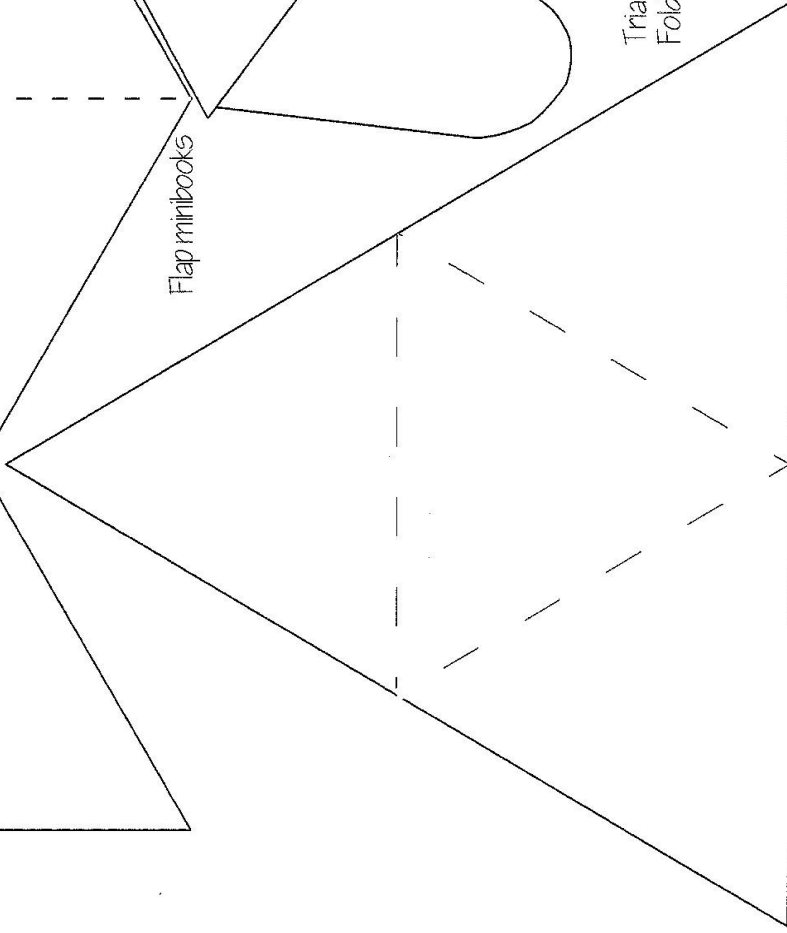

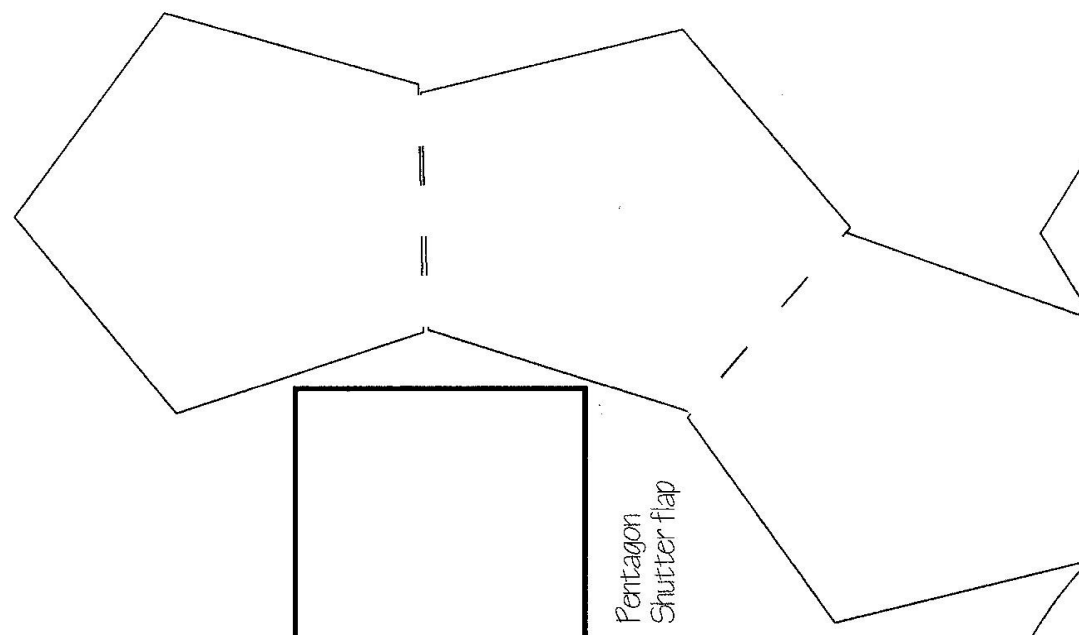

Pentagon
Shutter flap

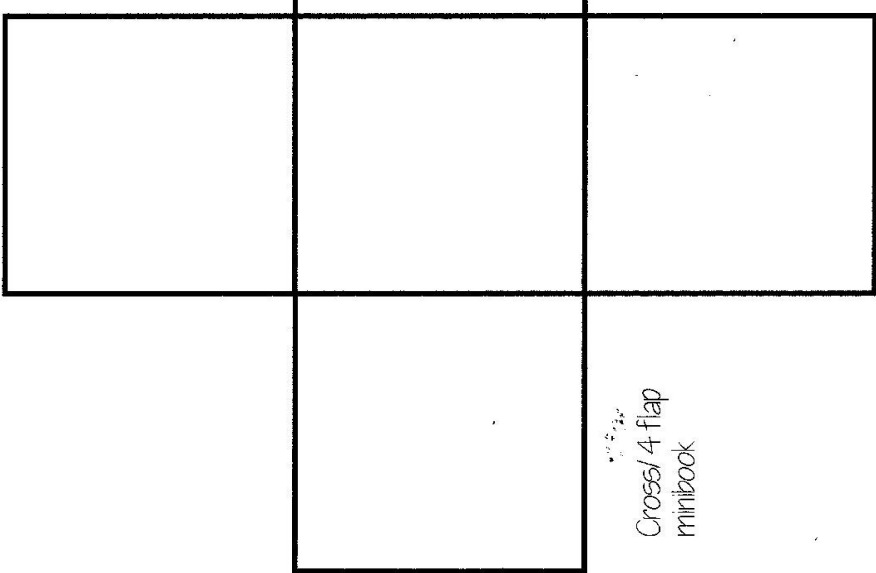

Cross/4 flap
minibook

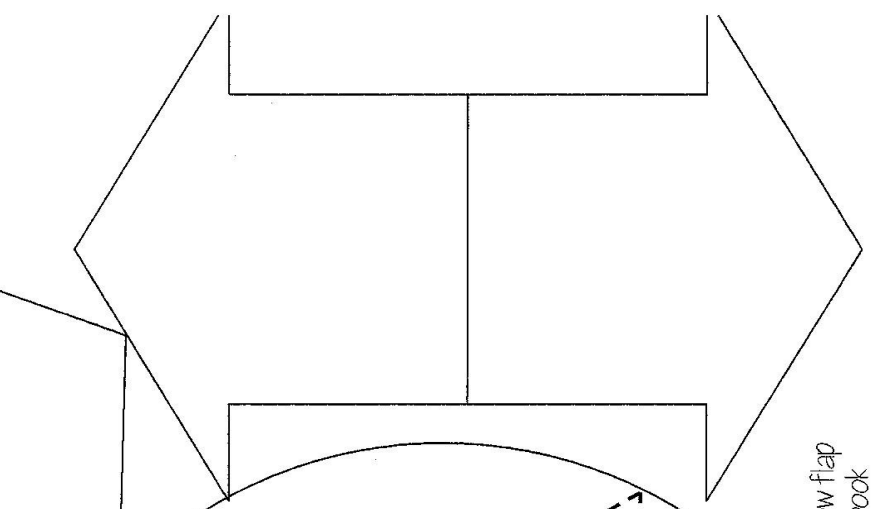

Arrow flap
minibook

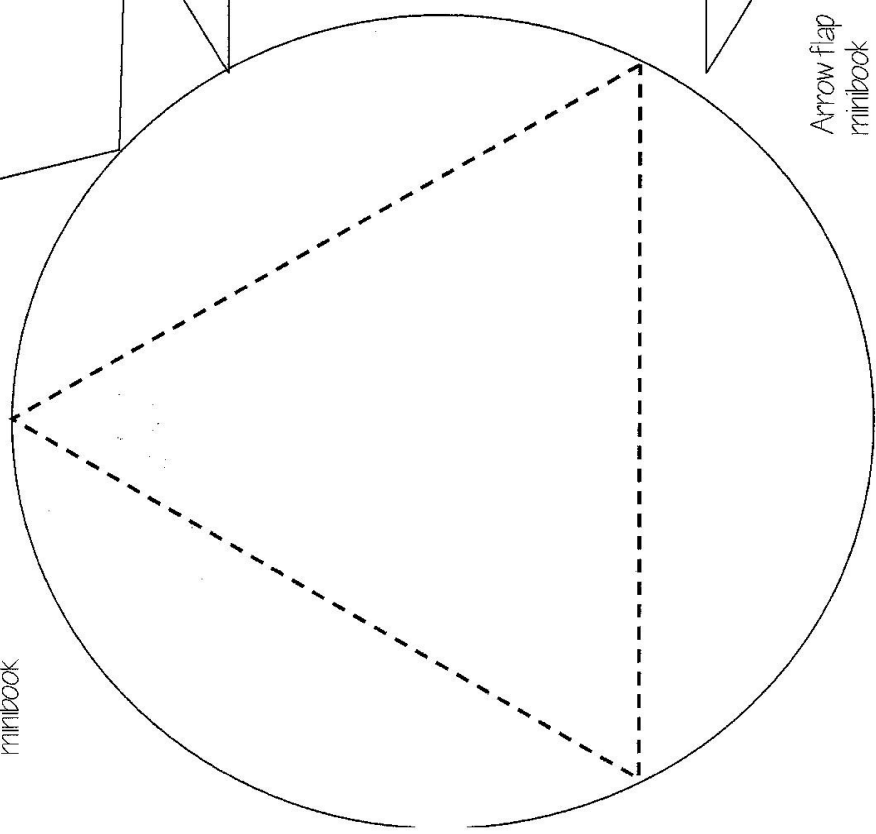

Triangle Petal
minibook

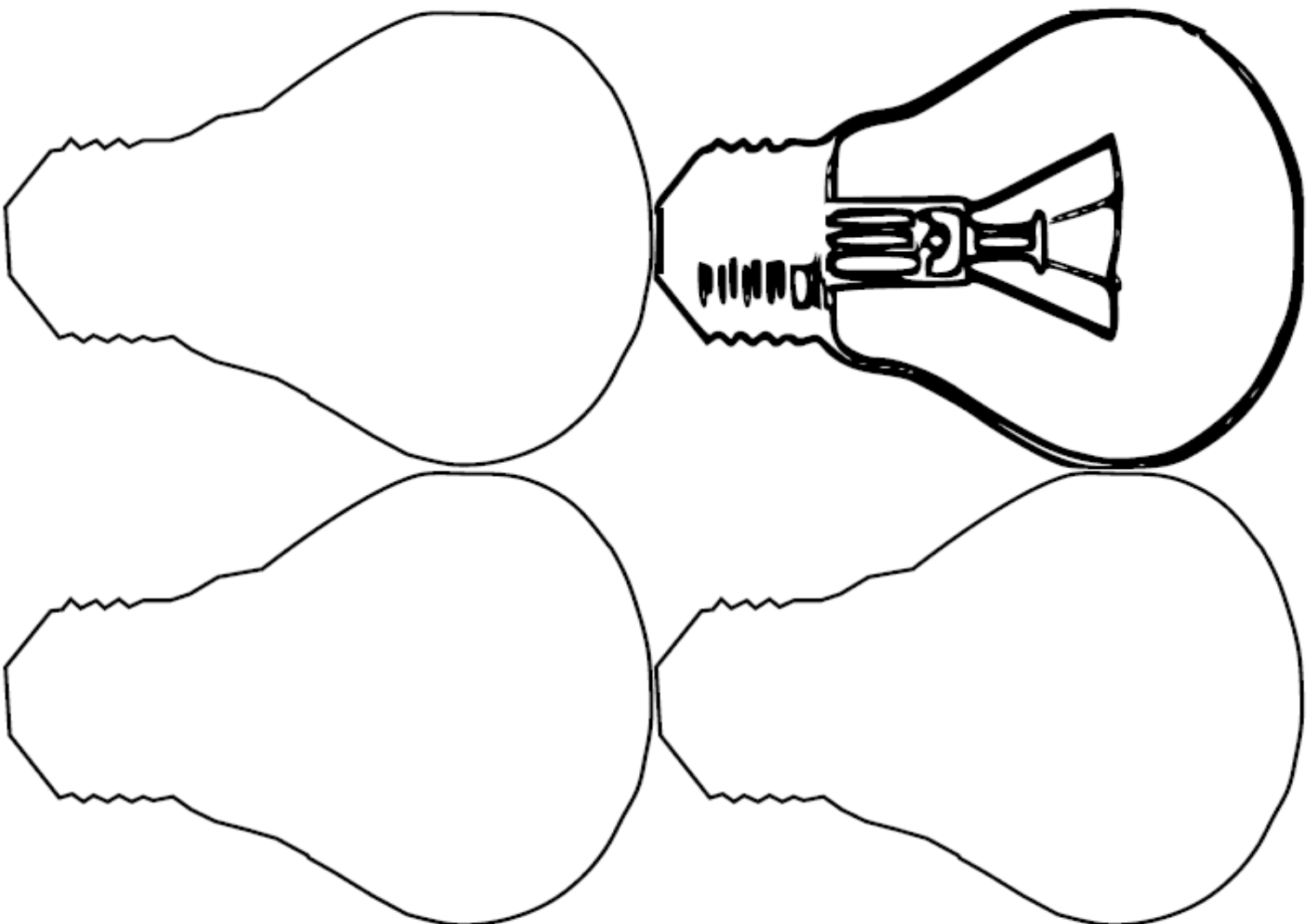

- Cut out on the solid lines as one piece.
- Fold in and out on the dotted lines like an accordion.
- Label as desired.

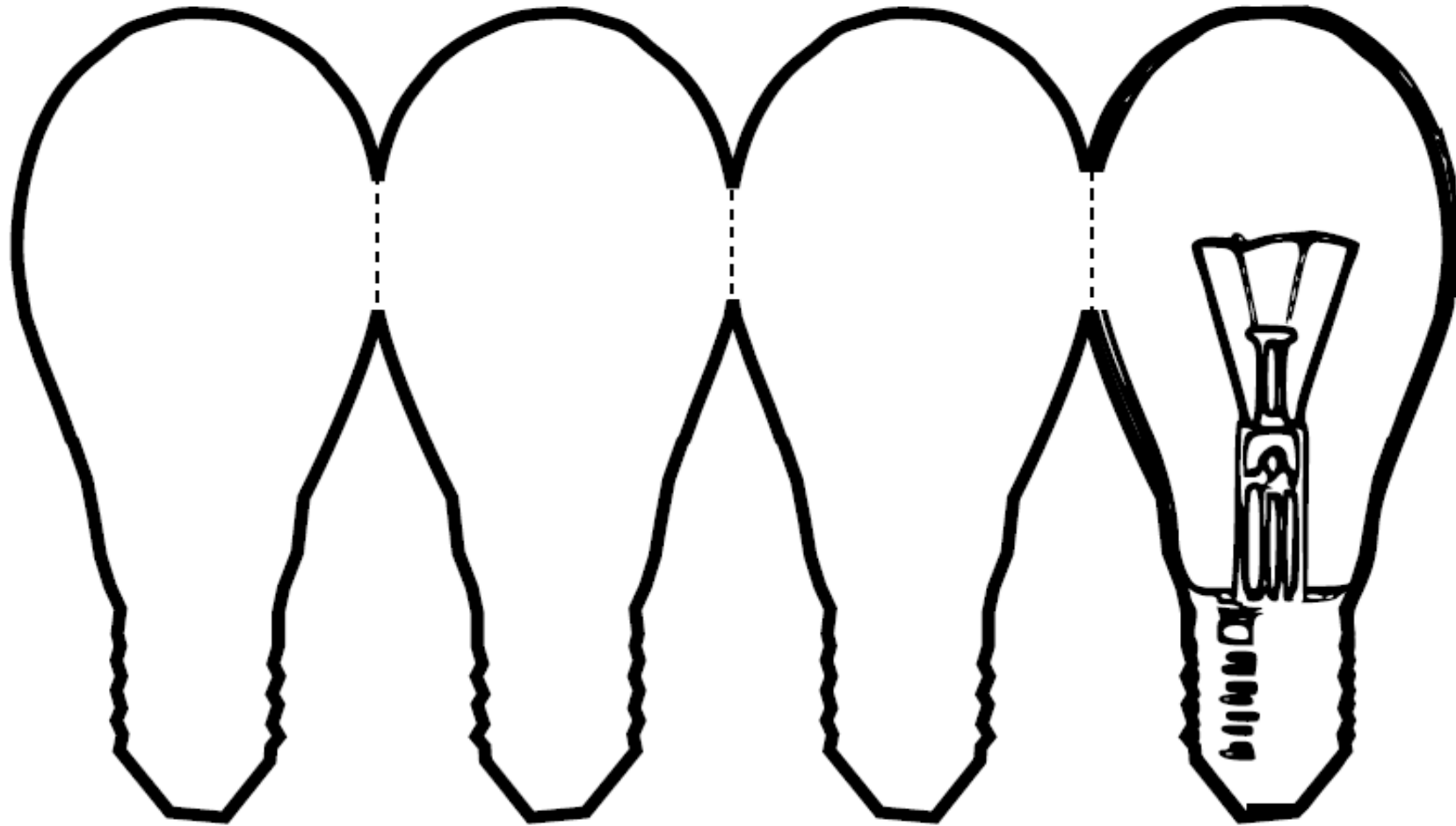

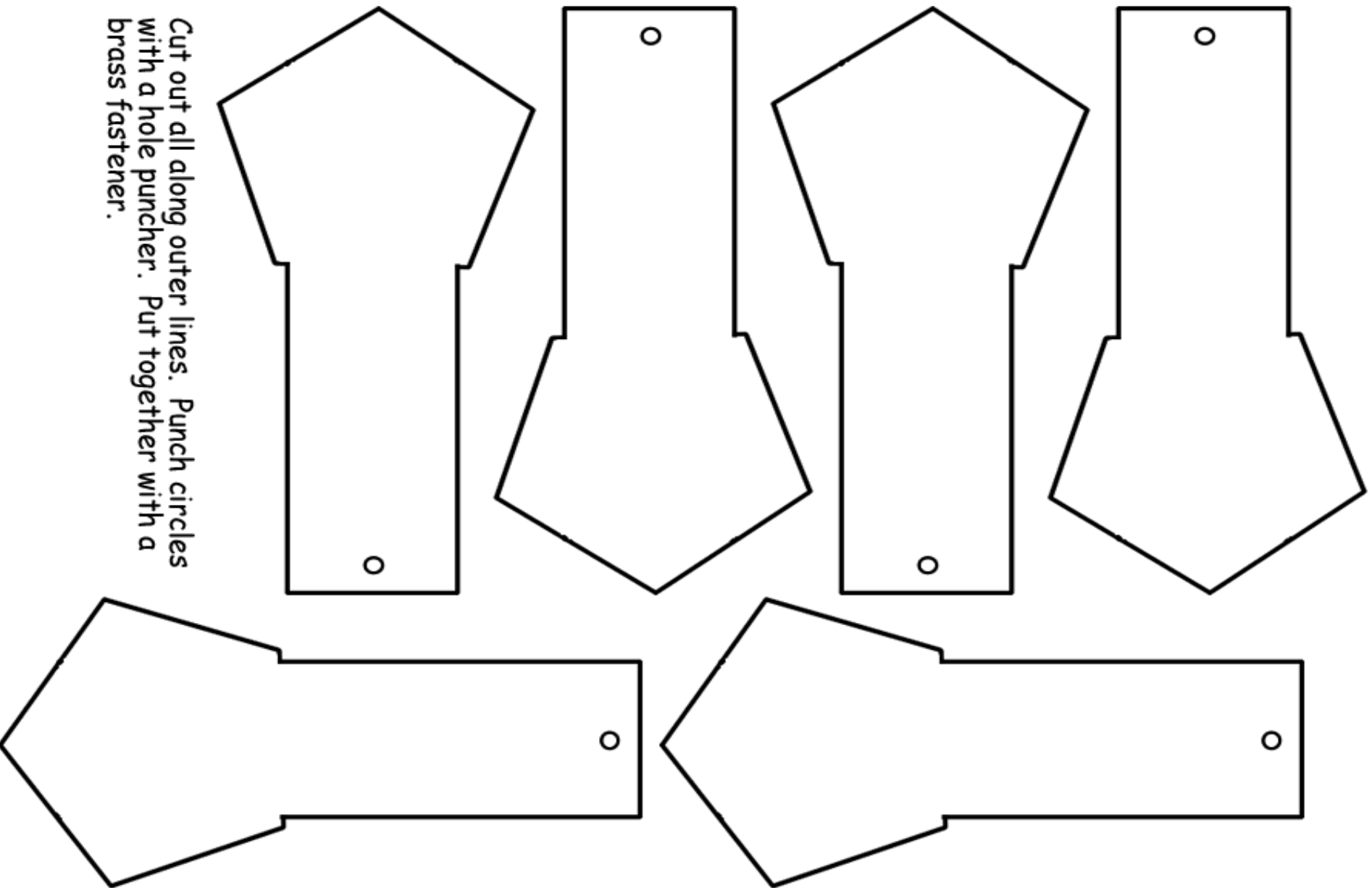

Cut out all along outer lines. Punch circles with a hole puncher. Put together with a brass fastener.

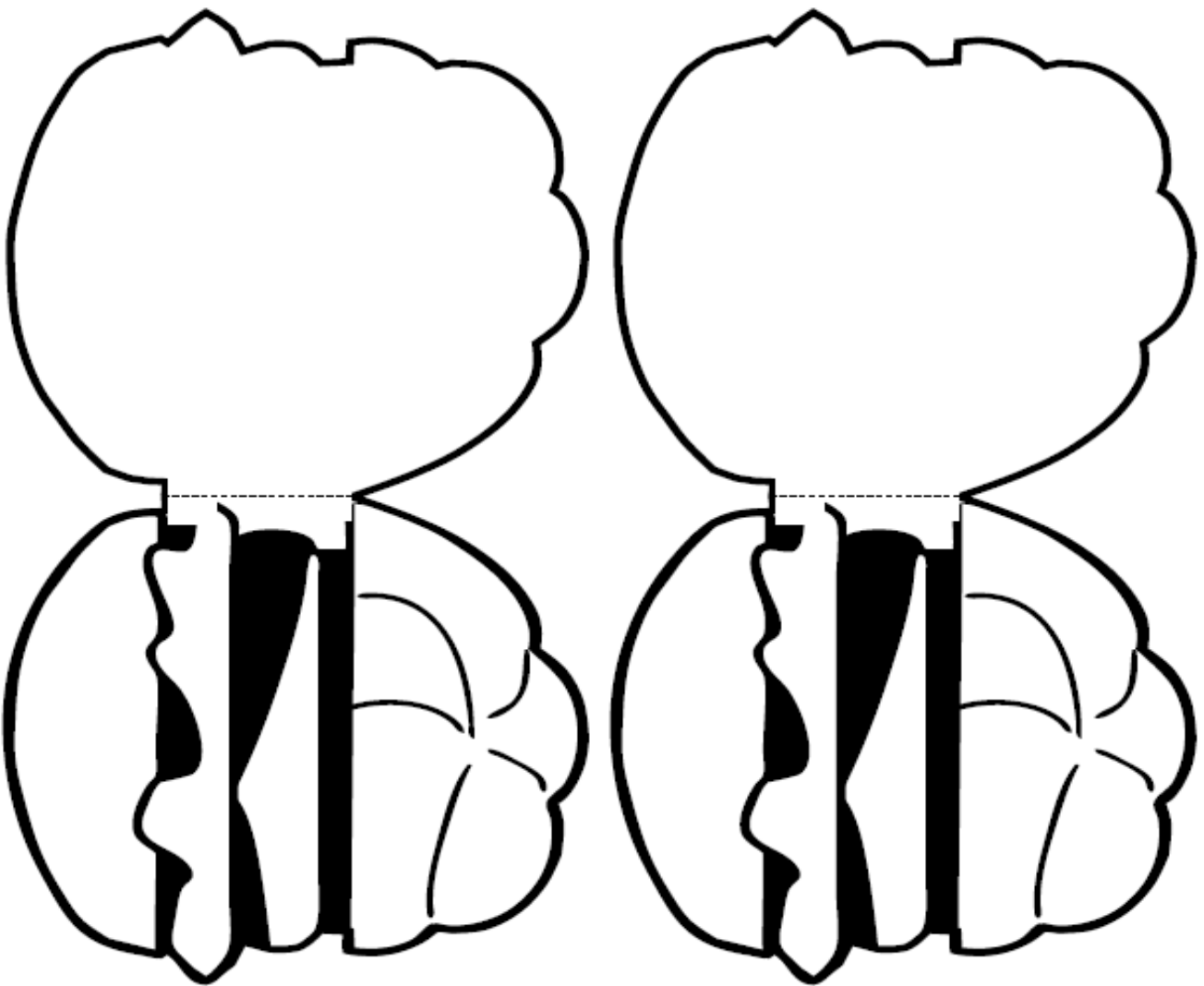

- Cut flower out as one piece on the solid line.
- Fold petals inward on the gray dotted lines of the hexagon.
- Label as desired.

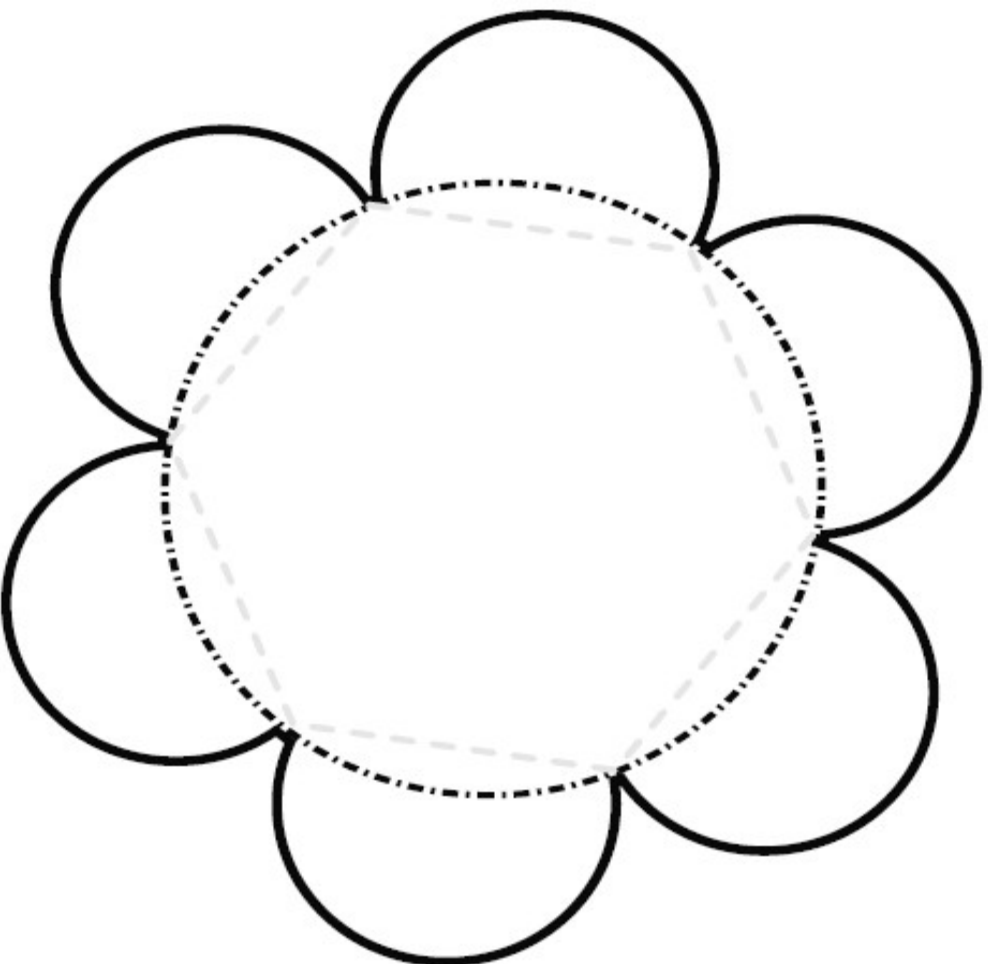

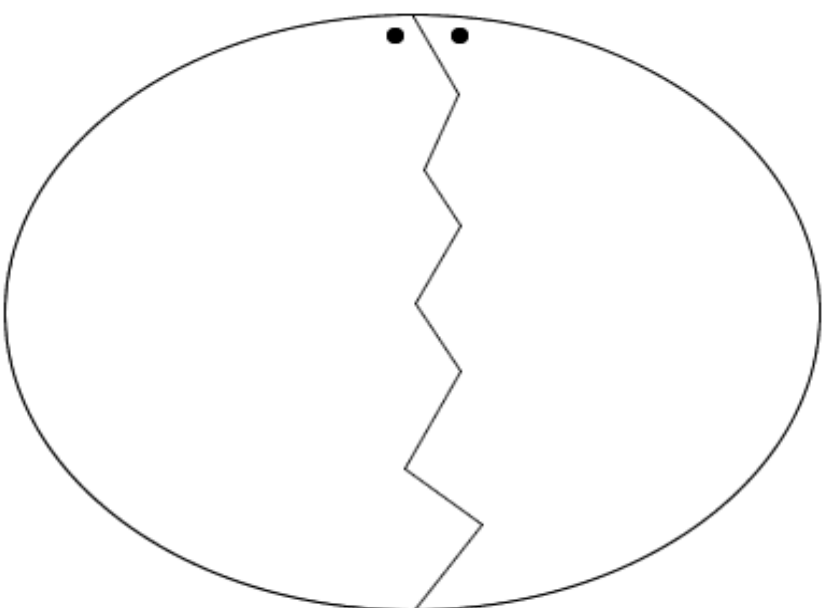
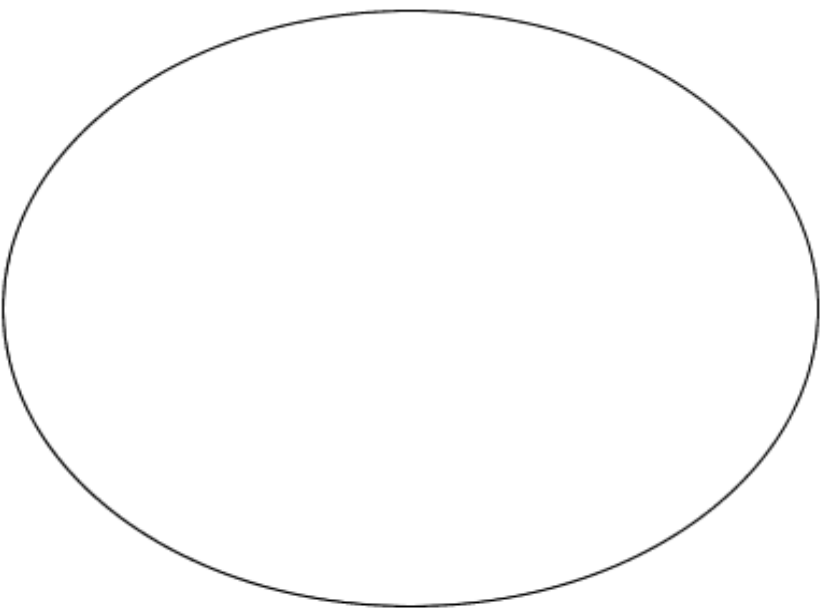

Cut out along solid lines.
Overlap the two halves of the
egg at the black dots. Put it
on top of the whole egg.
Attach with a brass fastener.

MiniBook Instructions

- Cut out each two pairs of pages as one rectangular piece.
- Fold each pair of pages in half with the graphics on the outside.
- Stack the pairs of pages on top of each other in order, starting with the title page.
- Staple on the left side.

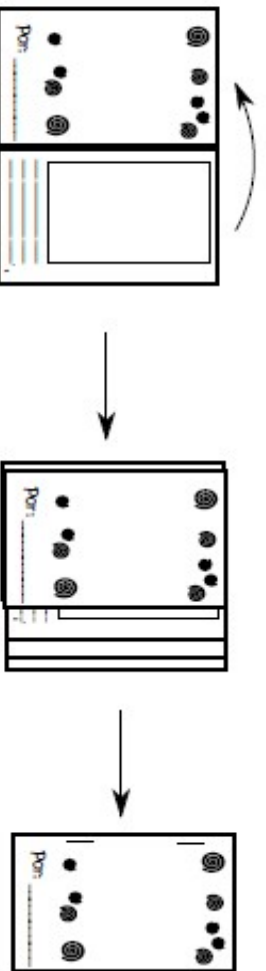



Por: _____

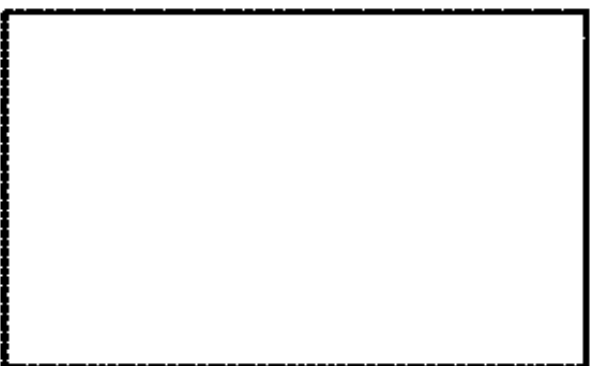



1



2



3

 <p>_____</p> <p>_____</p> <p>_____</p> <p>4</p>	 <p>_____</p> <p>_____</p> <p>_____</p> <p>5</p>
---	--

 <p>_____</p> <p>_____</p> <p>_____</p> <p>6</p>	<p>ELFIN</p>
--	--------------

1. Cut out the clock and the hands.
2. Put a hole in the dots on the hands and the x on the clock with the point of a pencil.
3. Place the hands on the x of the clock and stick a brass fastener through all three holes.

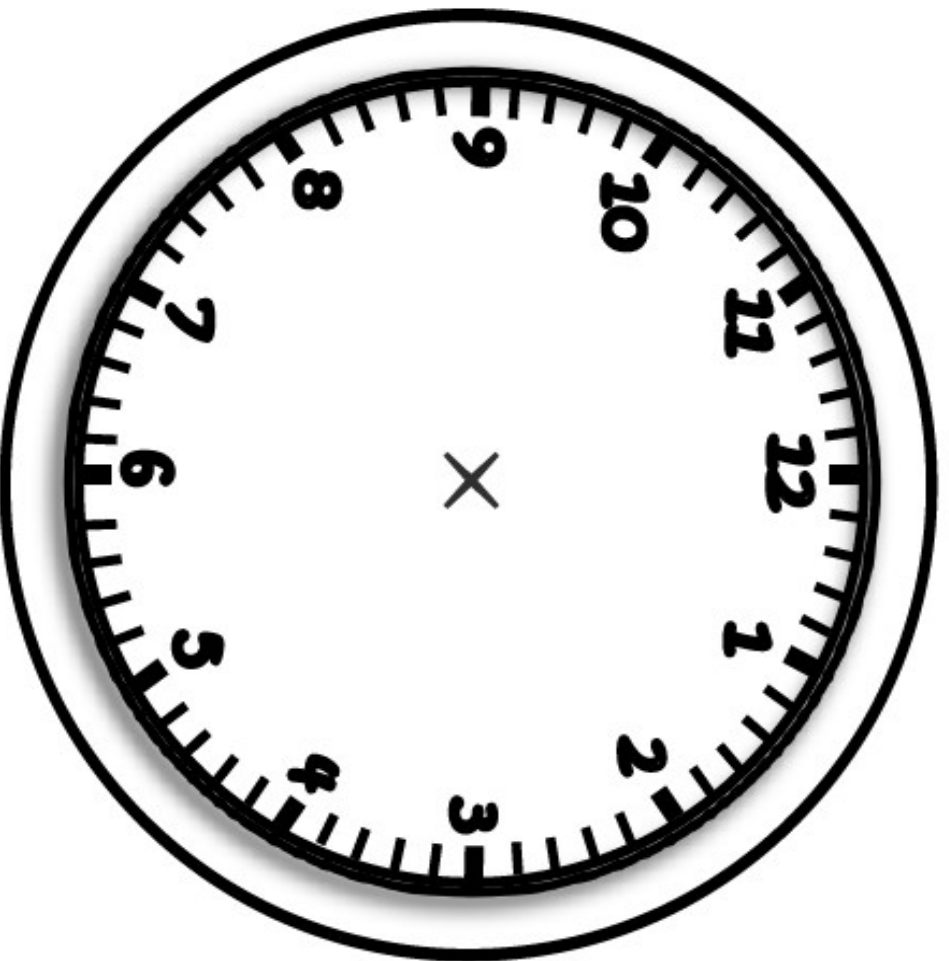
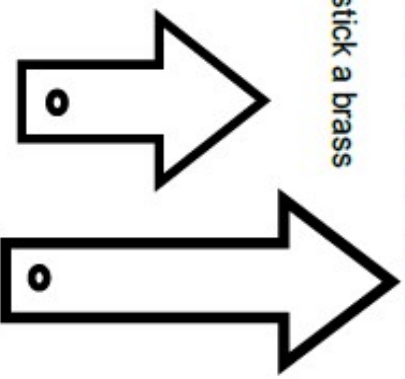

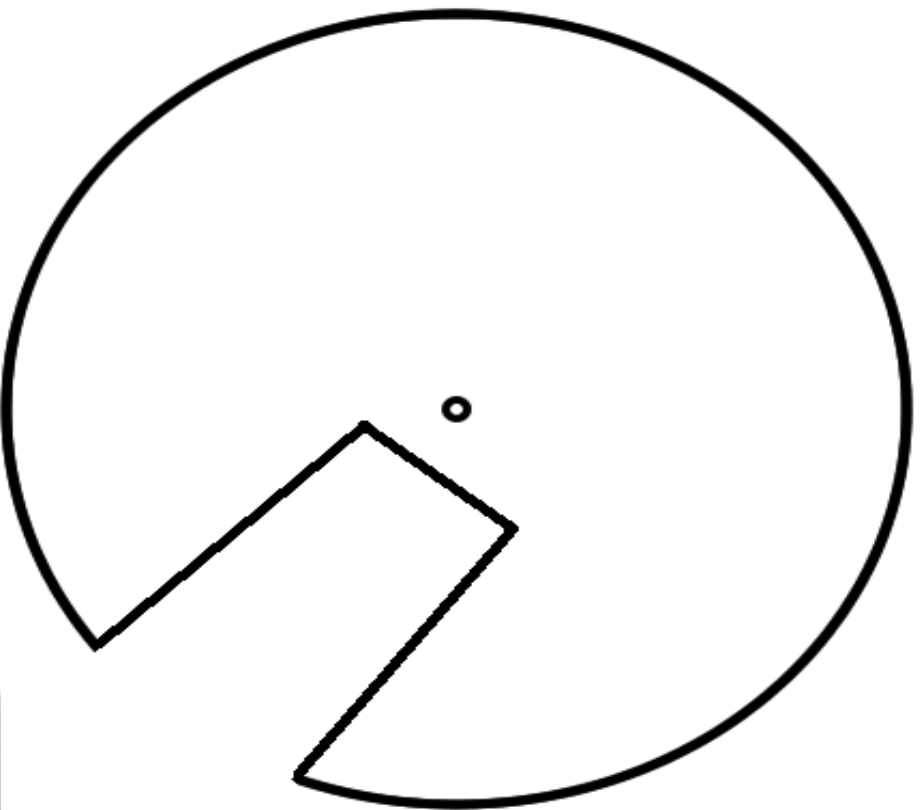

Cut out both circles along the outside dark lines. Cut out window on the circle with writing. Put the circle with the window on top of the other circle. Attach circles with a brass fastener at the middle, small circle.

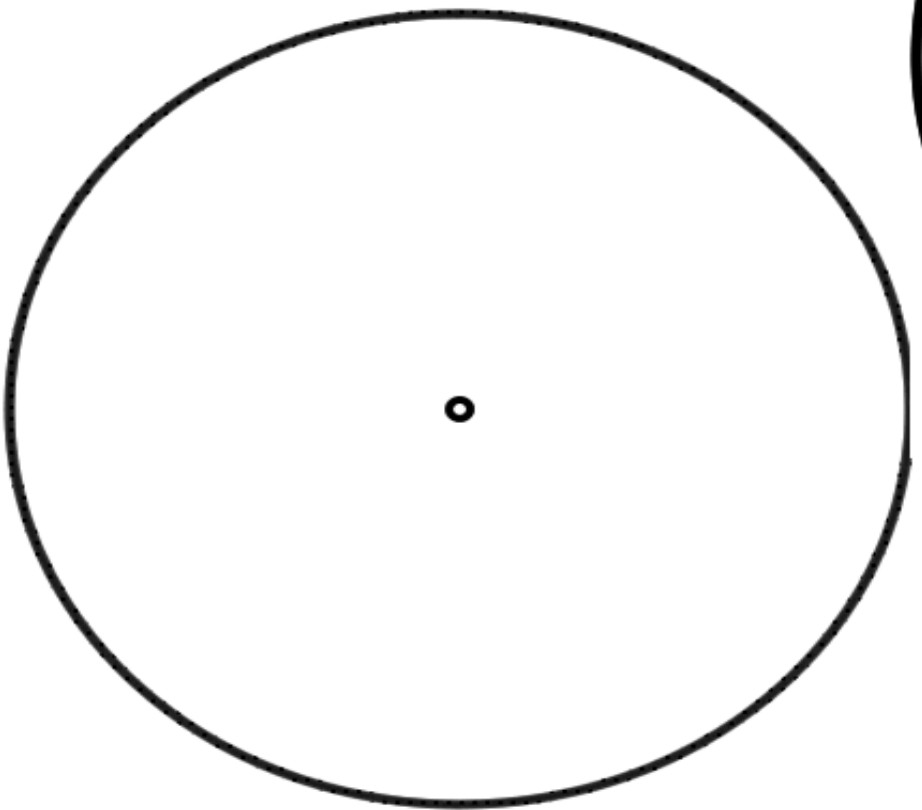

Cut out the three rectangles as ONE piece.
Using the black line as your guide, fold the
top rectangle down. Fold the left rectangle
over (again, using the black line as your
guide).

www.homeschoolshare.com

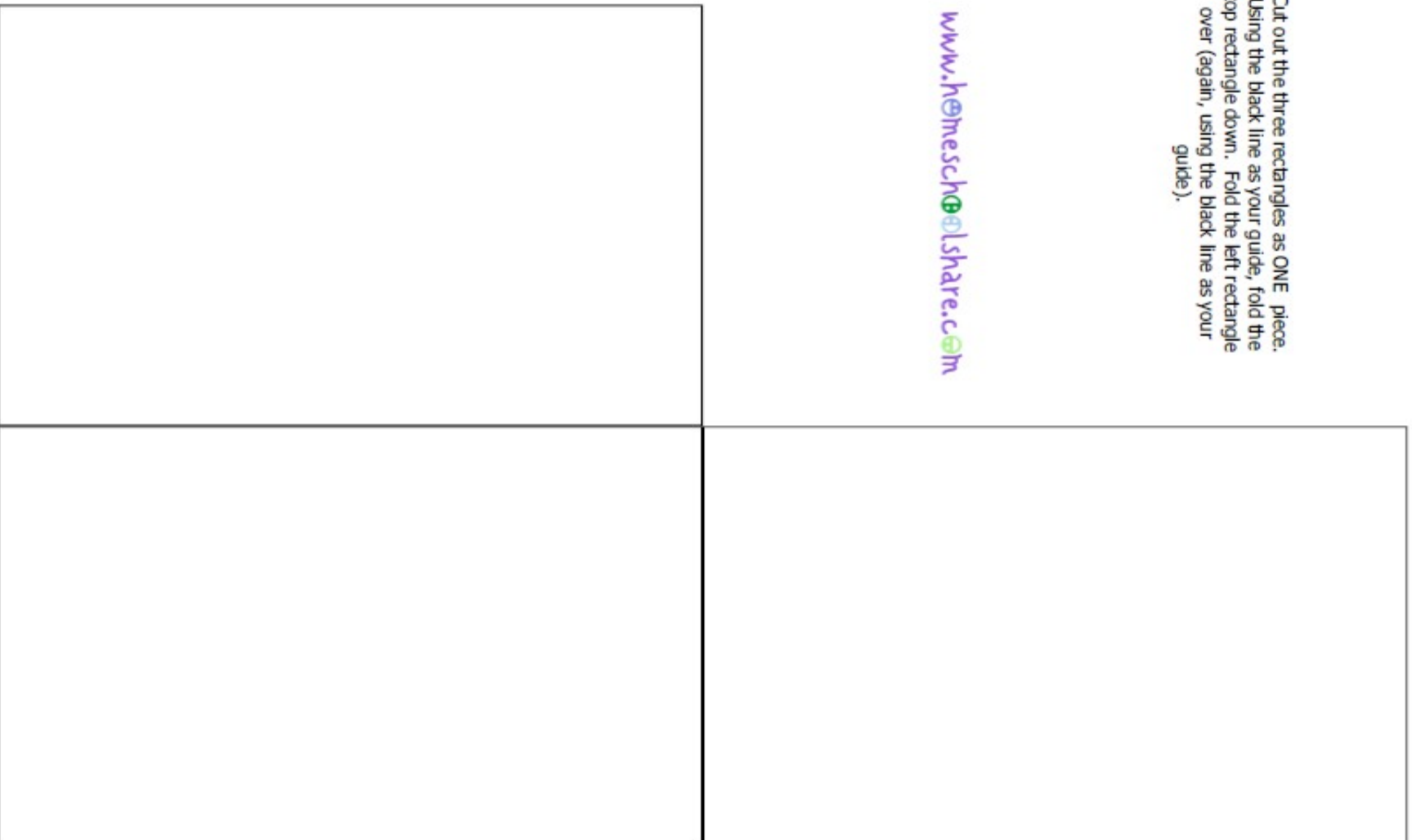

Cut L-shape out as ONE piece. Fold the top of the L shape down. Fold the left rectangle in over the existing flap.

www.homeschoolshare.com



Cut out this shape as ONE PIECE. Fold on each solid line. Use the first section for your title. Write or paste whatever you want into the book. Glue the back of the last section to your lapbook.

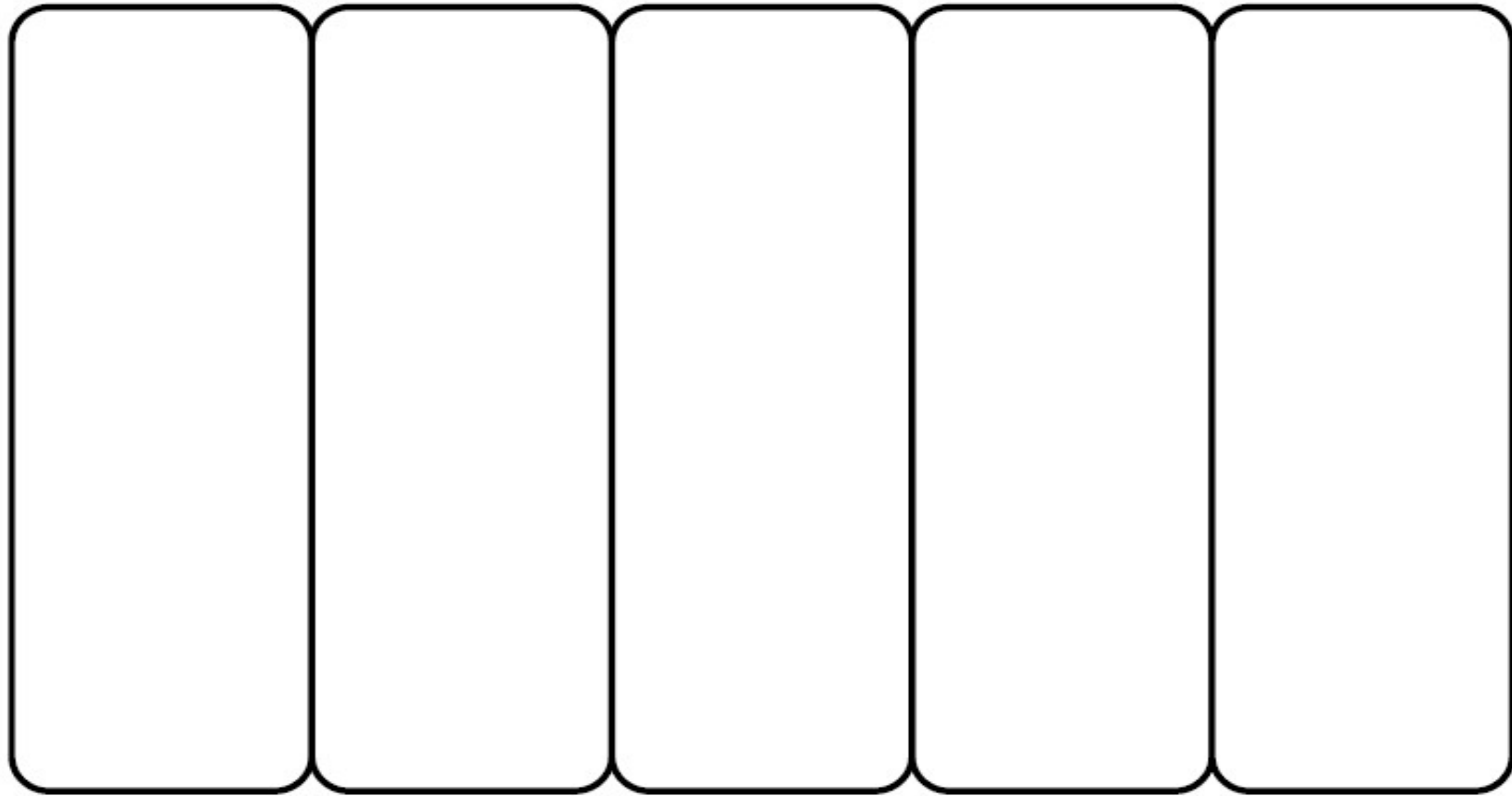

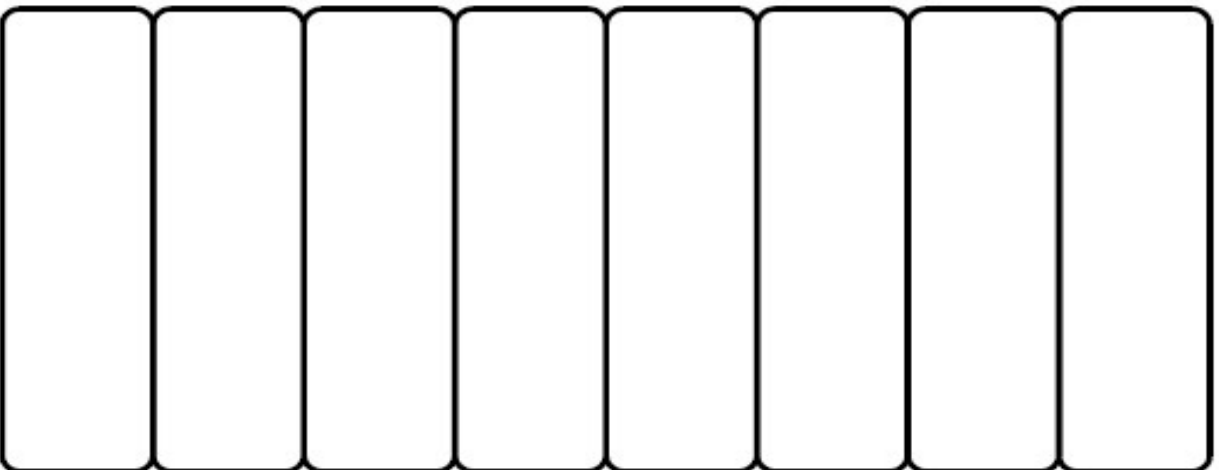

Cut this mini book out as ONE
PIECE. Fold on each solid line (back
and forth in accordion style). Use
the first section for your title. Use
each segment however you wish.
Paste the back of the last section
into your lapbook.

Cut out shapes on solid black lines. Fold on dotted lines like an accordion (back and forth, back and forth). If you need less areas to write, cut one/some off. If you need more, print another strip. Glue the back of the last space on the first piece to the front of the first space on the second piece.

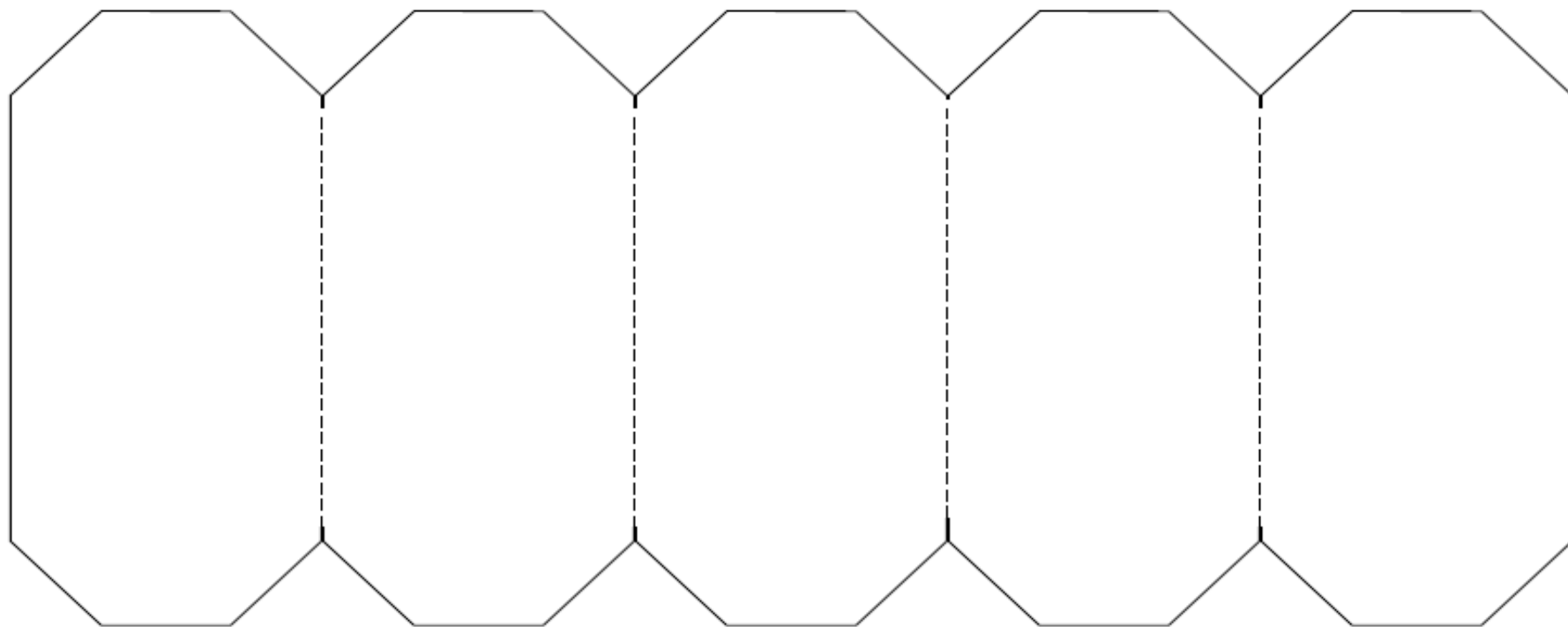

Cut out shapes on solid black lines. Fold on dotted lines like an accordion (back and forth, back and forth). If you need less areas to write, cut one/ some off. If you need more, print another strip. Glue the back of the last space on the first piece to the front of the first space on the second piece.

www.homeschoolshare.com

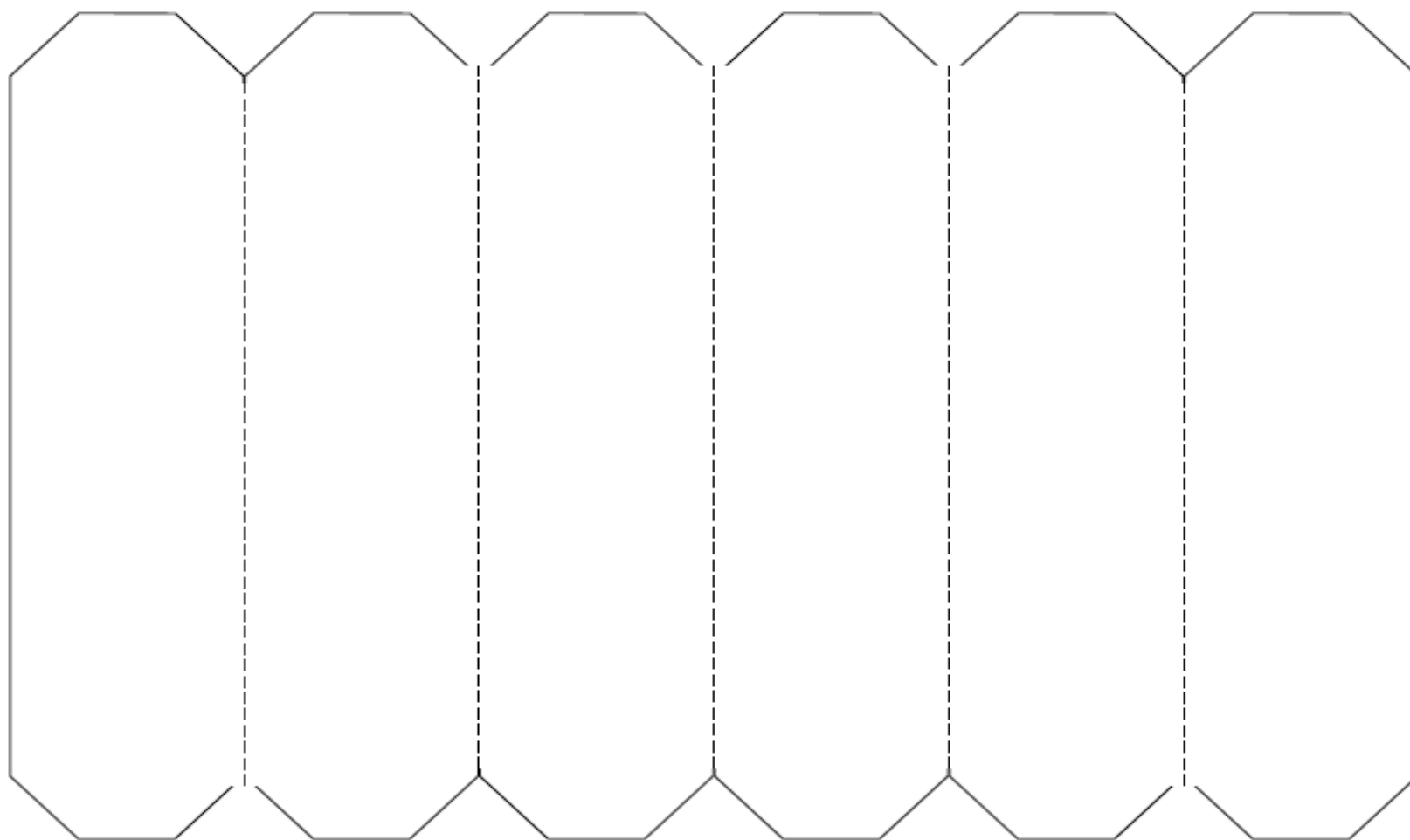

Cut out shapes on solid black lines. Fold on dotted lines like an accordion (back and forth, back and forth). If you need less areas to write, cut one/some off. If you need more, print another strip. Glue the back of the last space on the first piece to the front of the first space on the second piece.

www.homeschoolshare.com

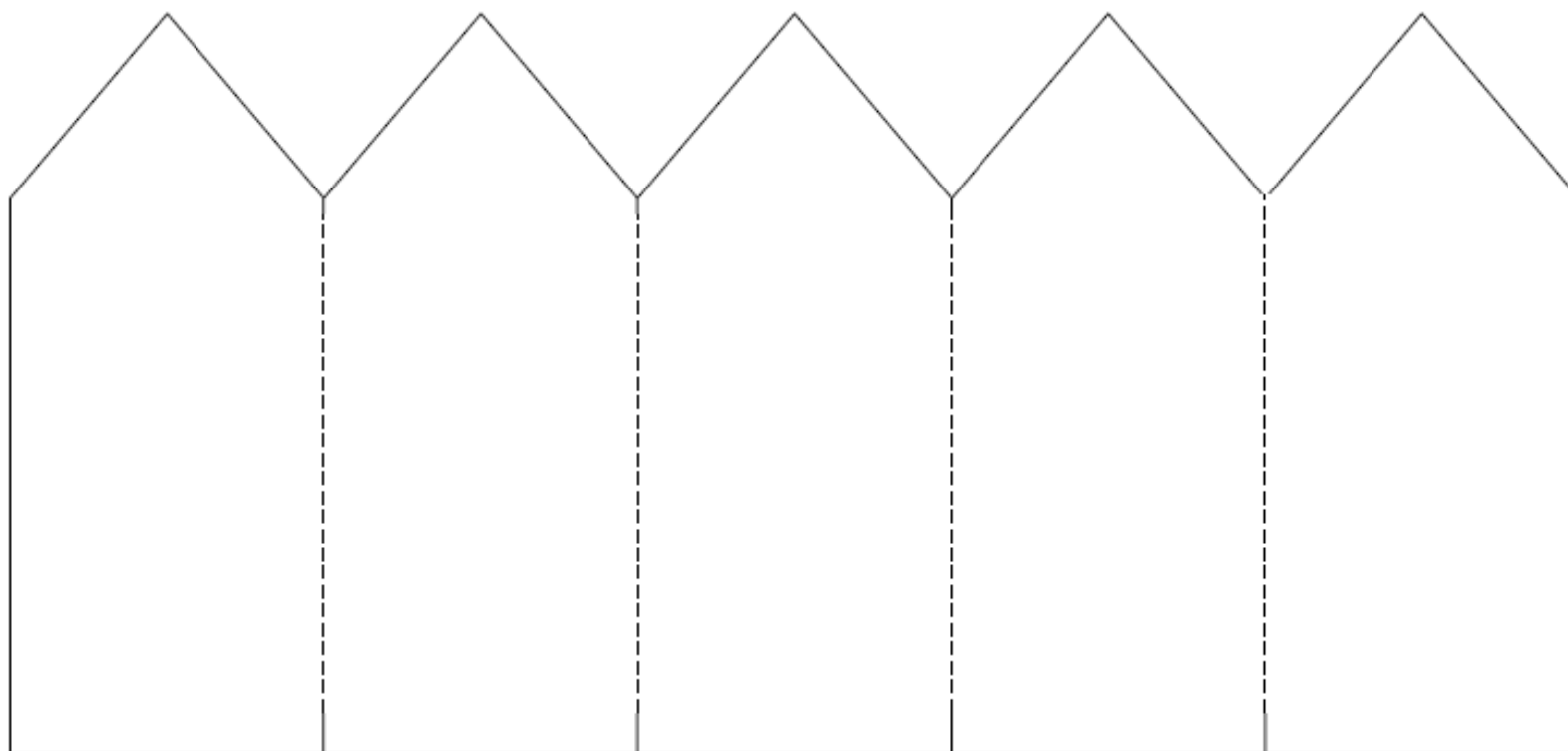

Cut out shapes on solid black lines. Fold on dotted lines like an accordion (back and forth, back and forth). If you need less areas to write, cut one/ some off. If you need more, print another strip. Glue the back of the last space on the first piece to the front of the first space on the second piece.

www.homeschoolshare.com

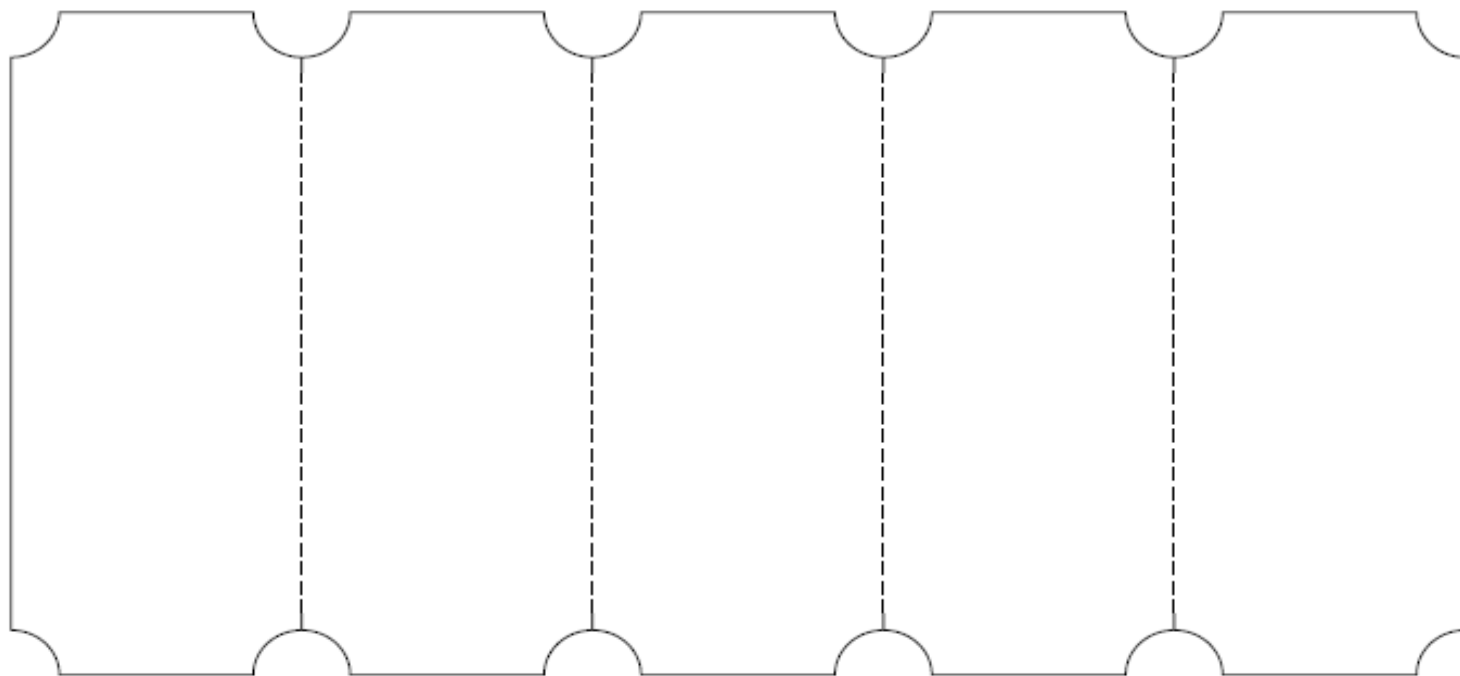

Cut book out as one piece. Fold right flap in. Fold left flap in. Fold in half. You should be able to use this book horizontally or vertically.

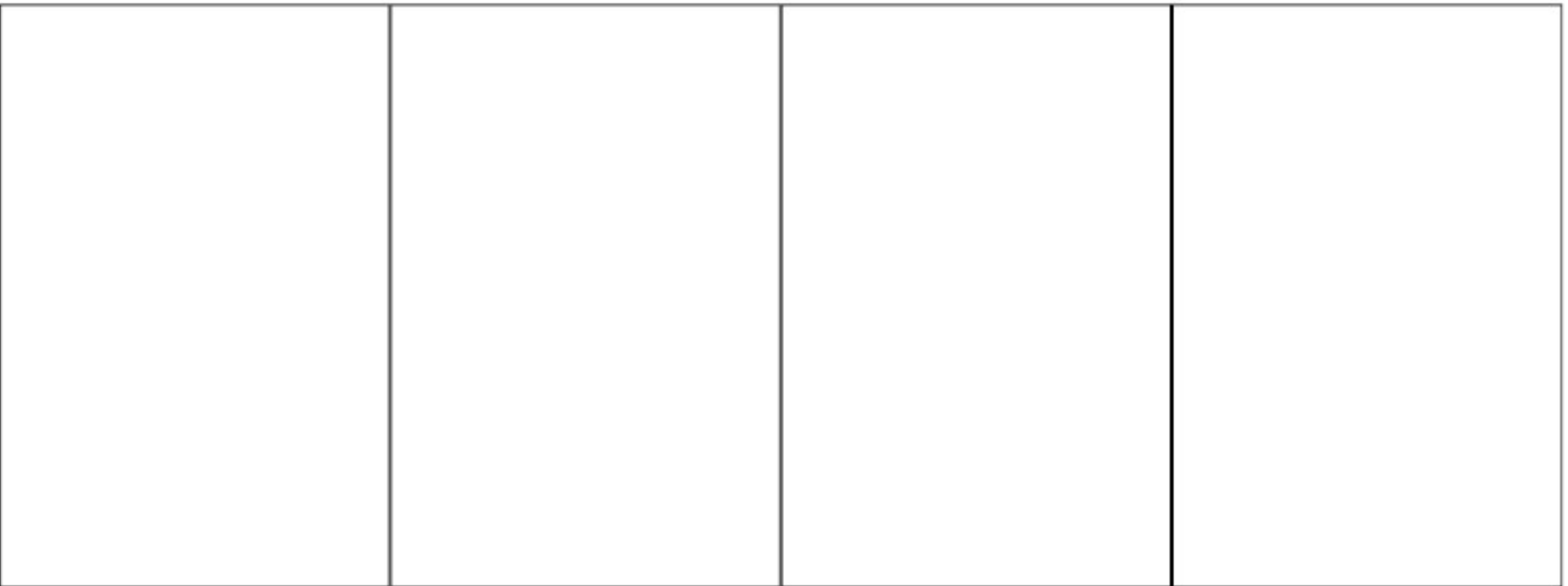

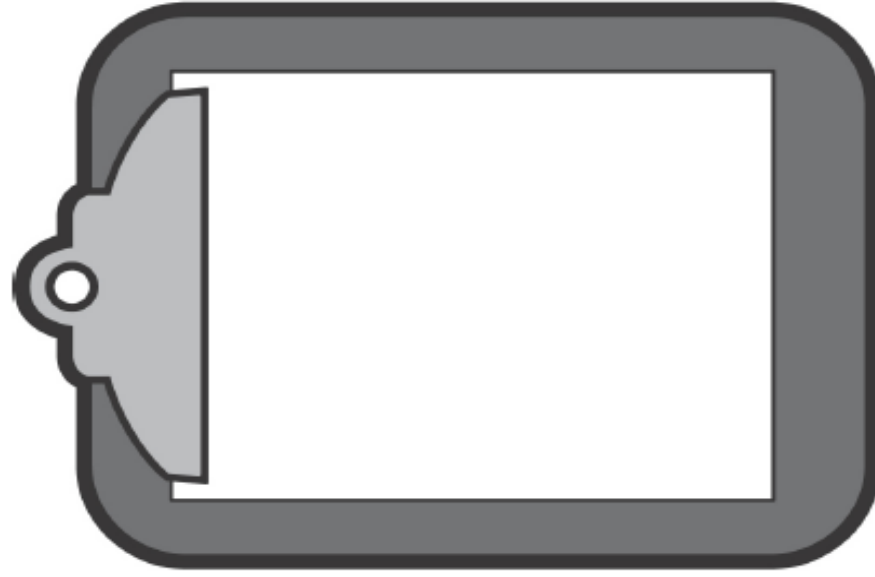
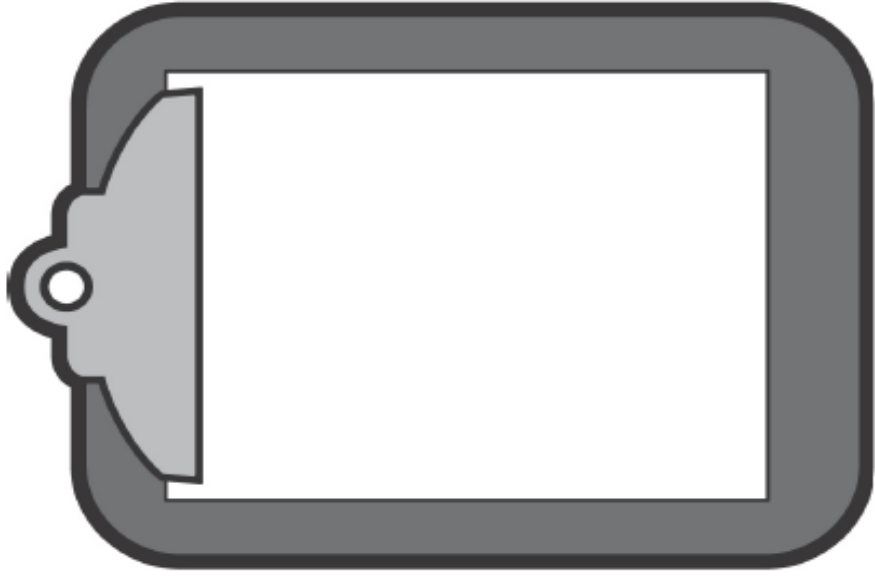
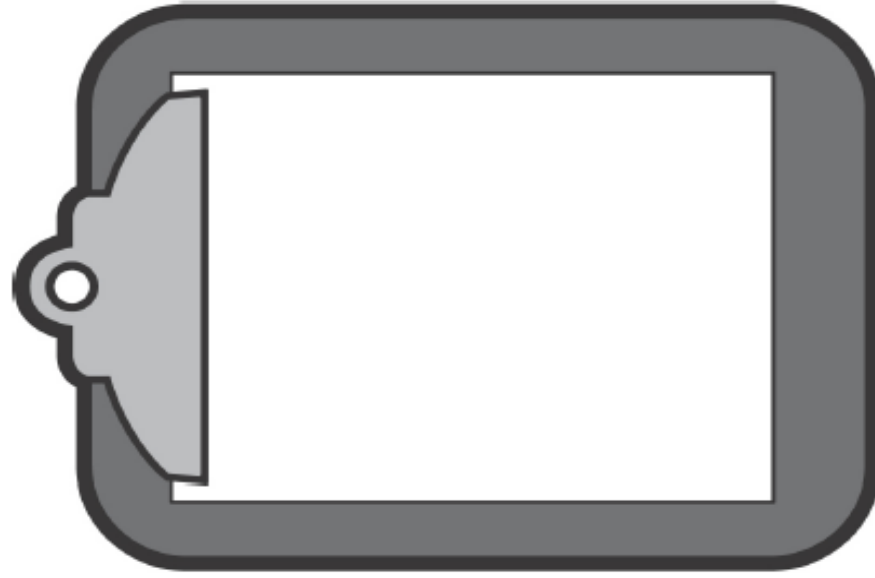
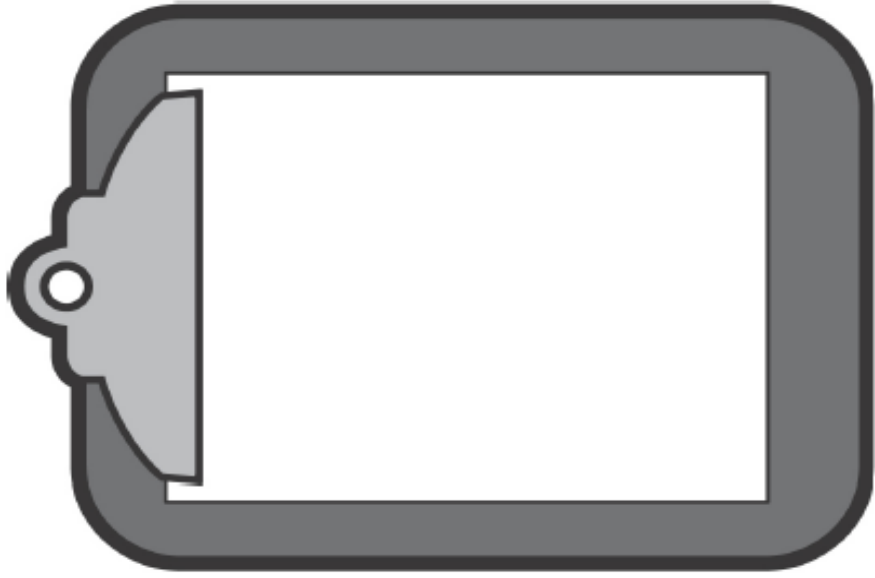

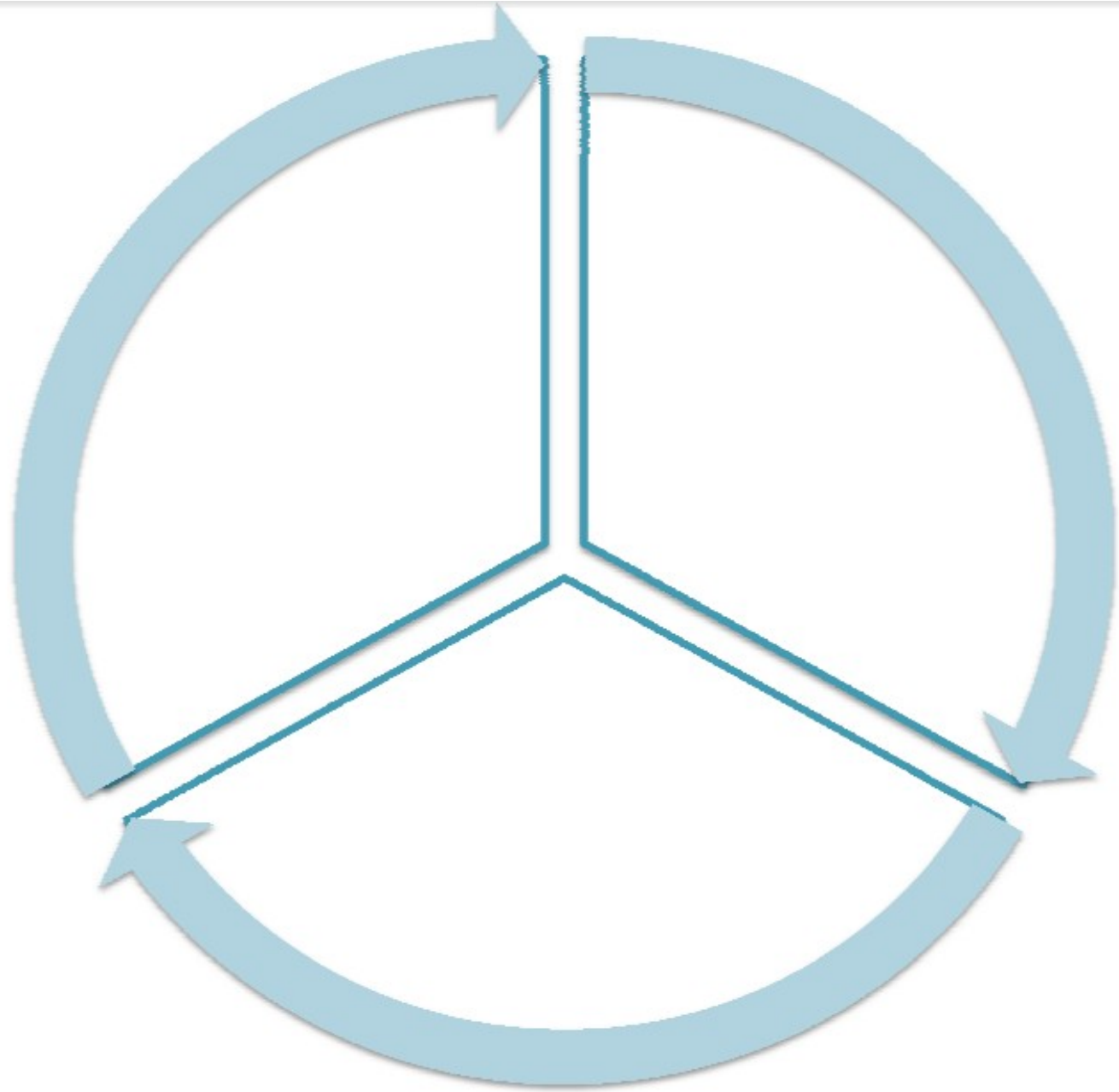

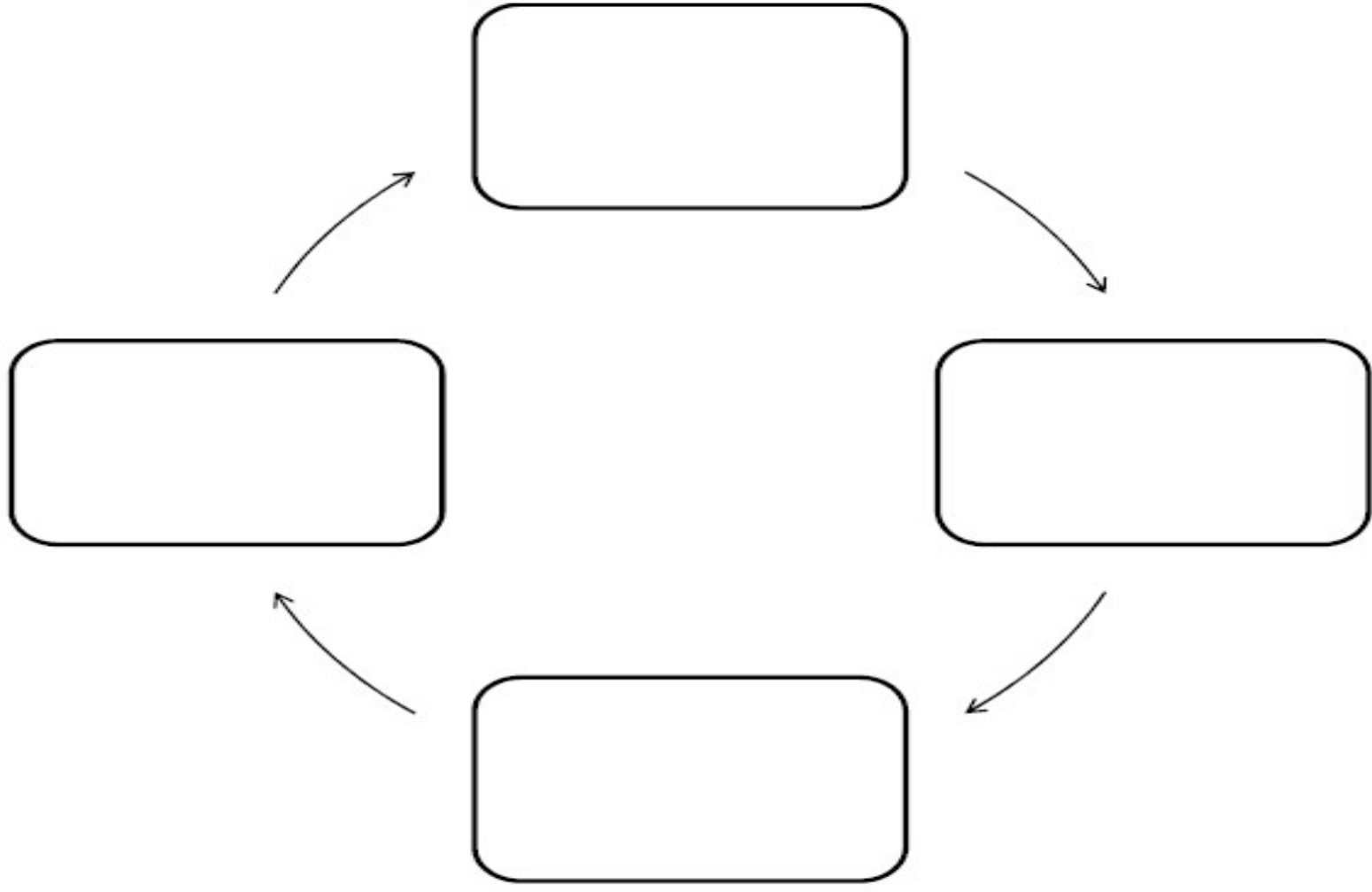

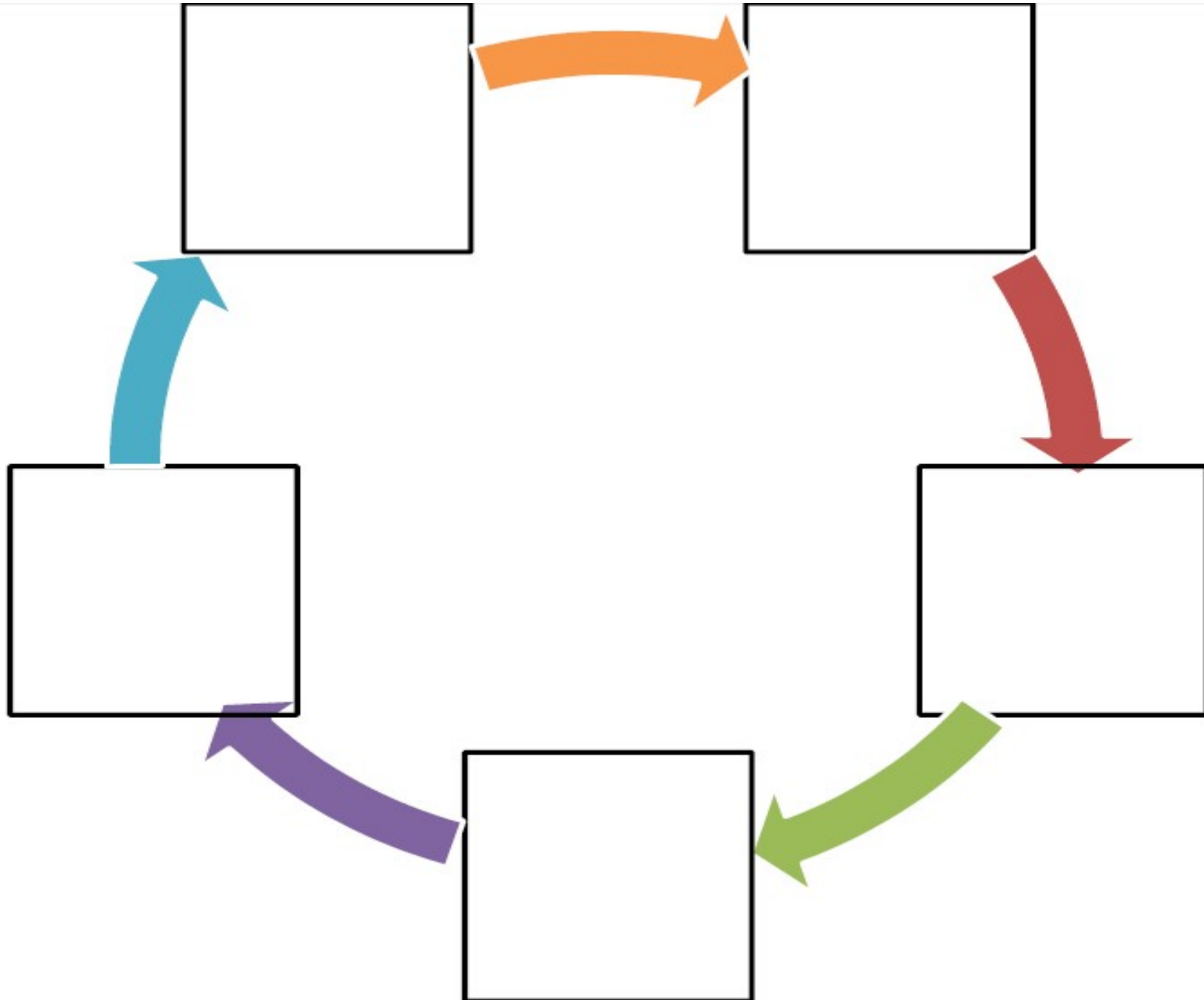

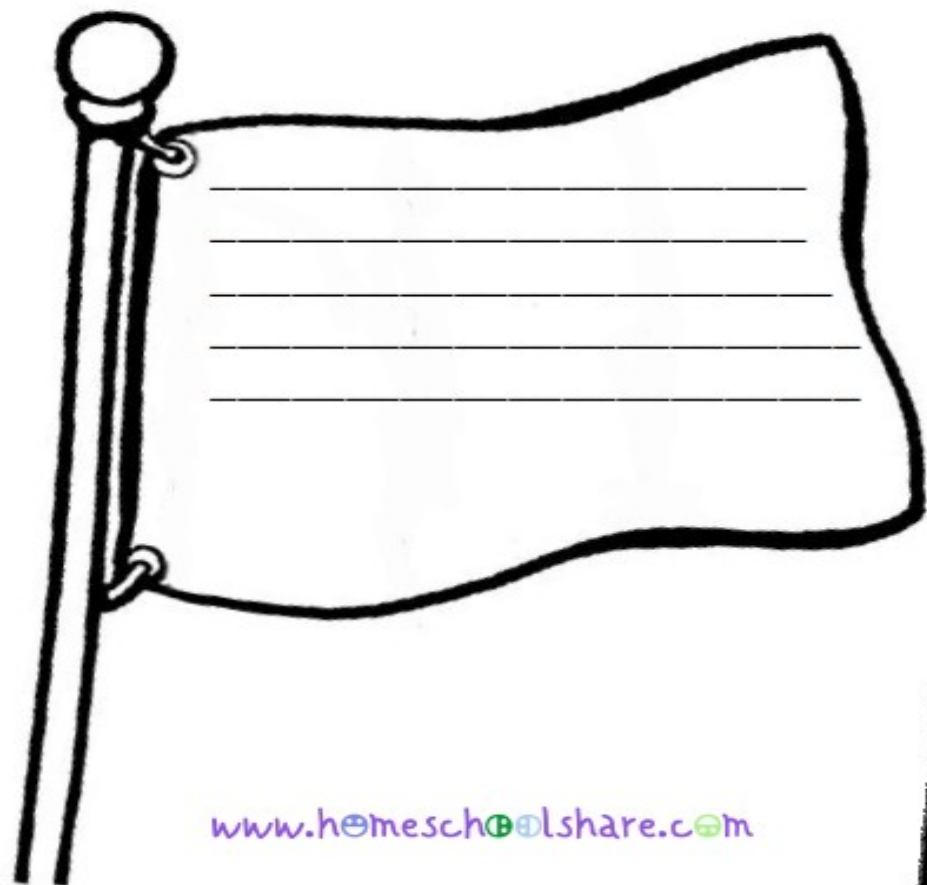

Cut each flag shape out. Stack in order with cover (Flag Facts) on top and staple on the left side.

www.homeschoolshare.com

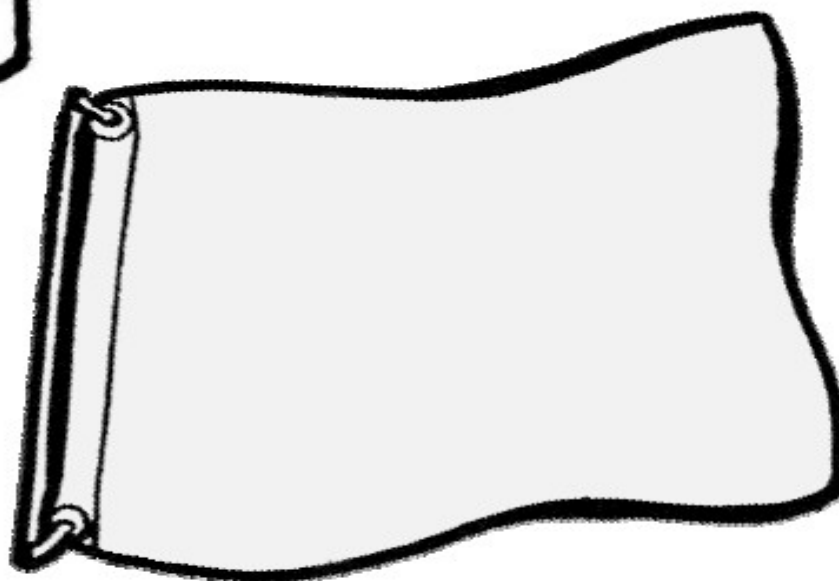

Cut out each book as one piece. Fold left side under. Fold right side under (it is the cover). Unfold book. Cut on the two lines between the names to form three flaps.

www.homeschoolshare.com

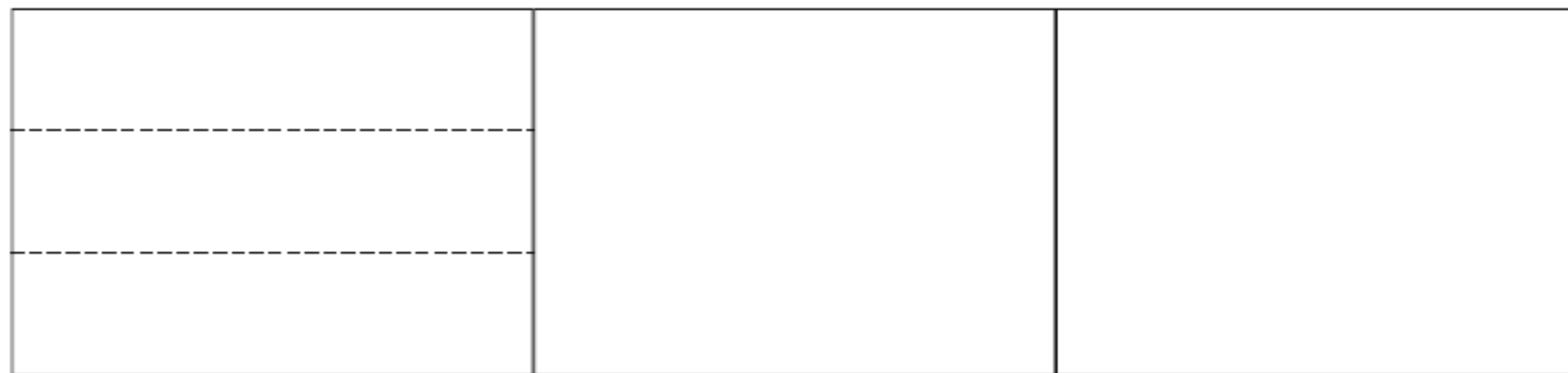
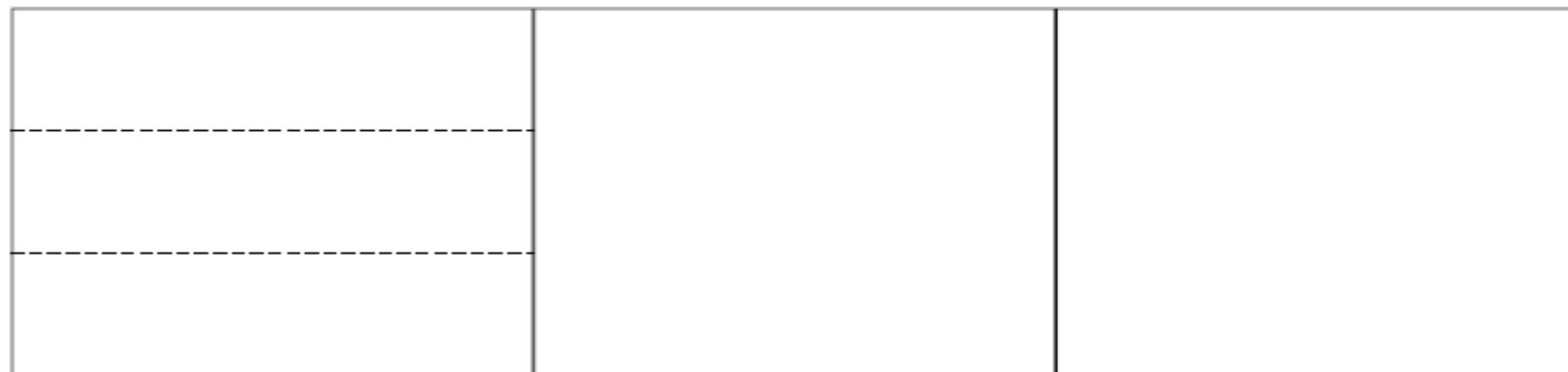

Cut out book as one piece. Fold left side in. Fold right side in. Open book.
Cut on dotted lines to form six flaps. Refold book.

www.homeschoolshare.com

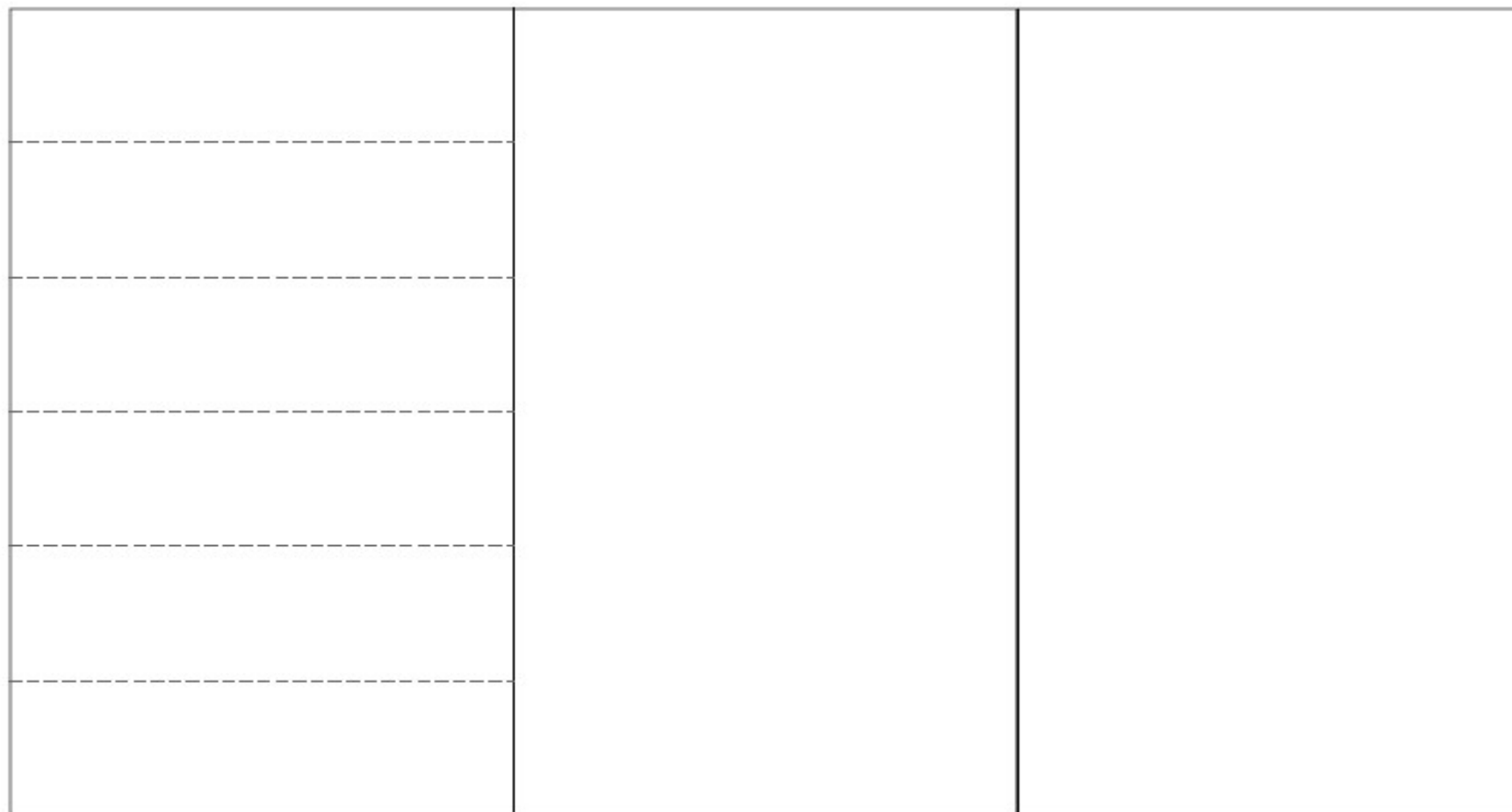

Cut out book as one piece. Fold left side in. Fold right side in. Open book. Cut on dotted line to form four flaps. Refold book.

www.homeschoolshare.com

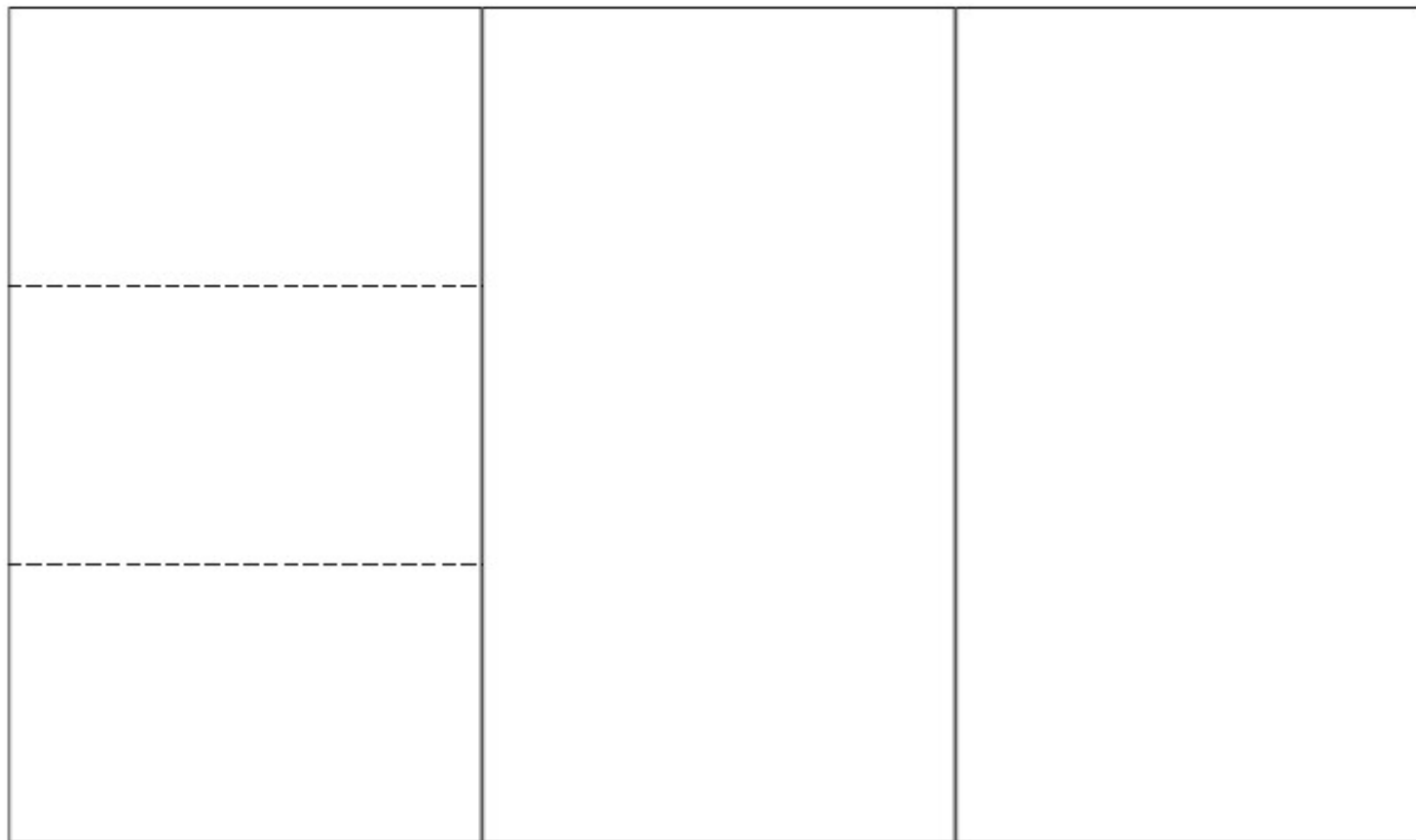

Cut out book as one piece. Fold left side in. Fold right side in. Open book. Cut on dotted line to form four flaps. Refold book.

www.homeschoolshare.com

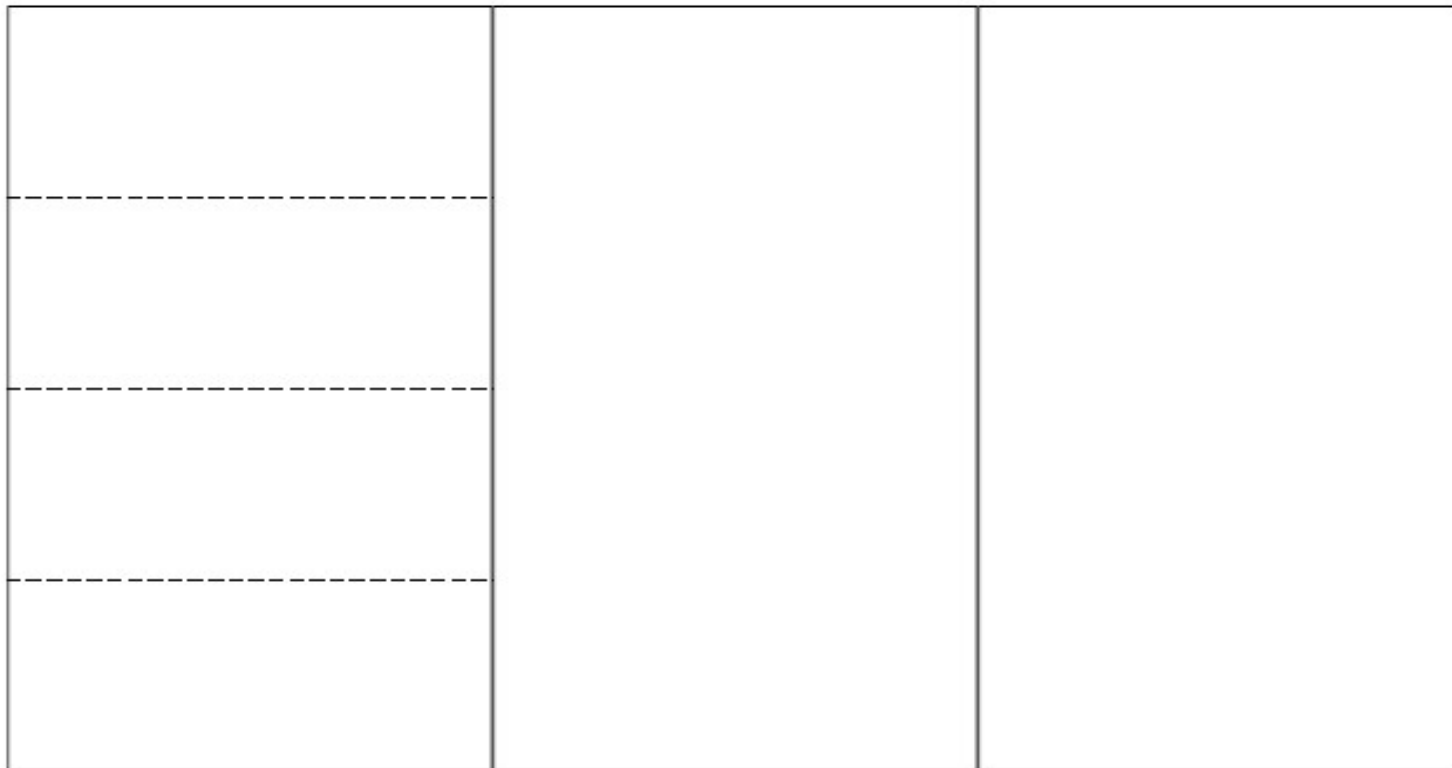

Cut out book as one piece. Fold left side in. Fold right side in. Open book.
Cut on dotted lines to form five flaps. Refold book.

www.homeschoolshare.com

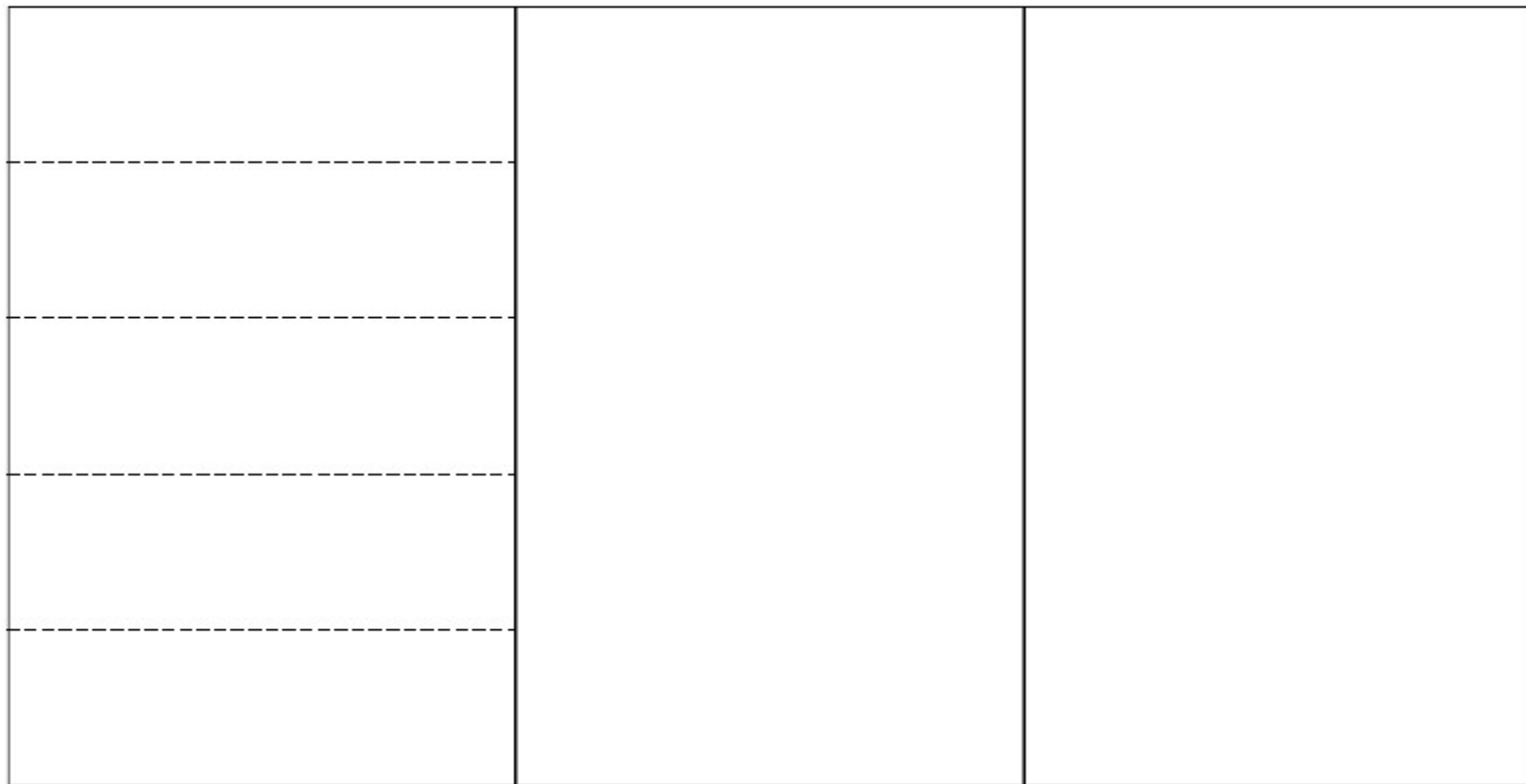



www.homeschoolshare.com

Do NOT print on cardstock. Cut book out. Fold both sides to the middle so that they interlock.

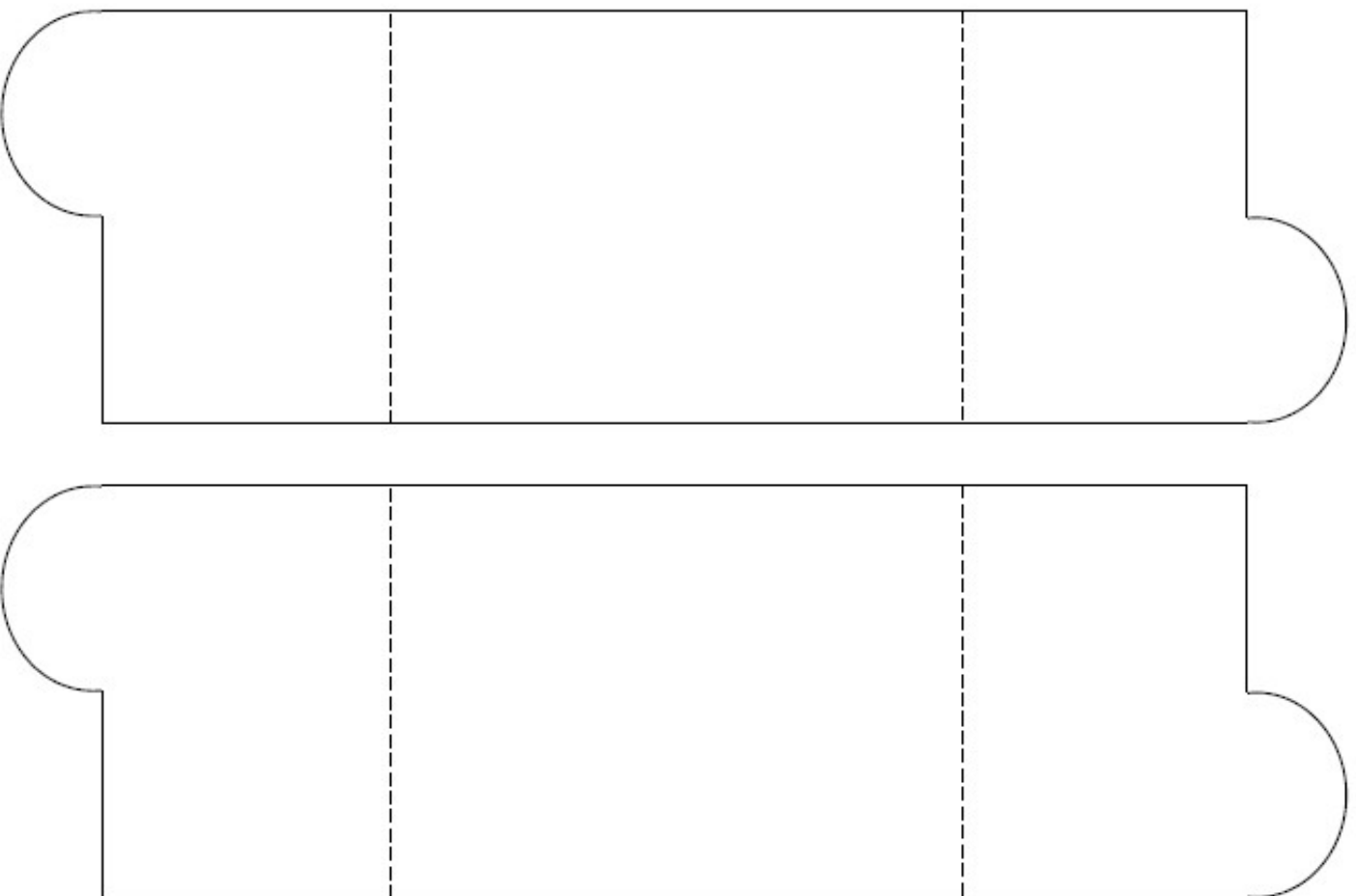

Do NOT print on cardstock. Cut books out. Fold both sides to the middle so that they interlock.

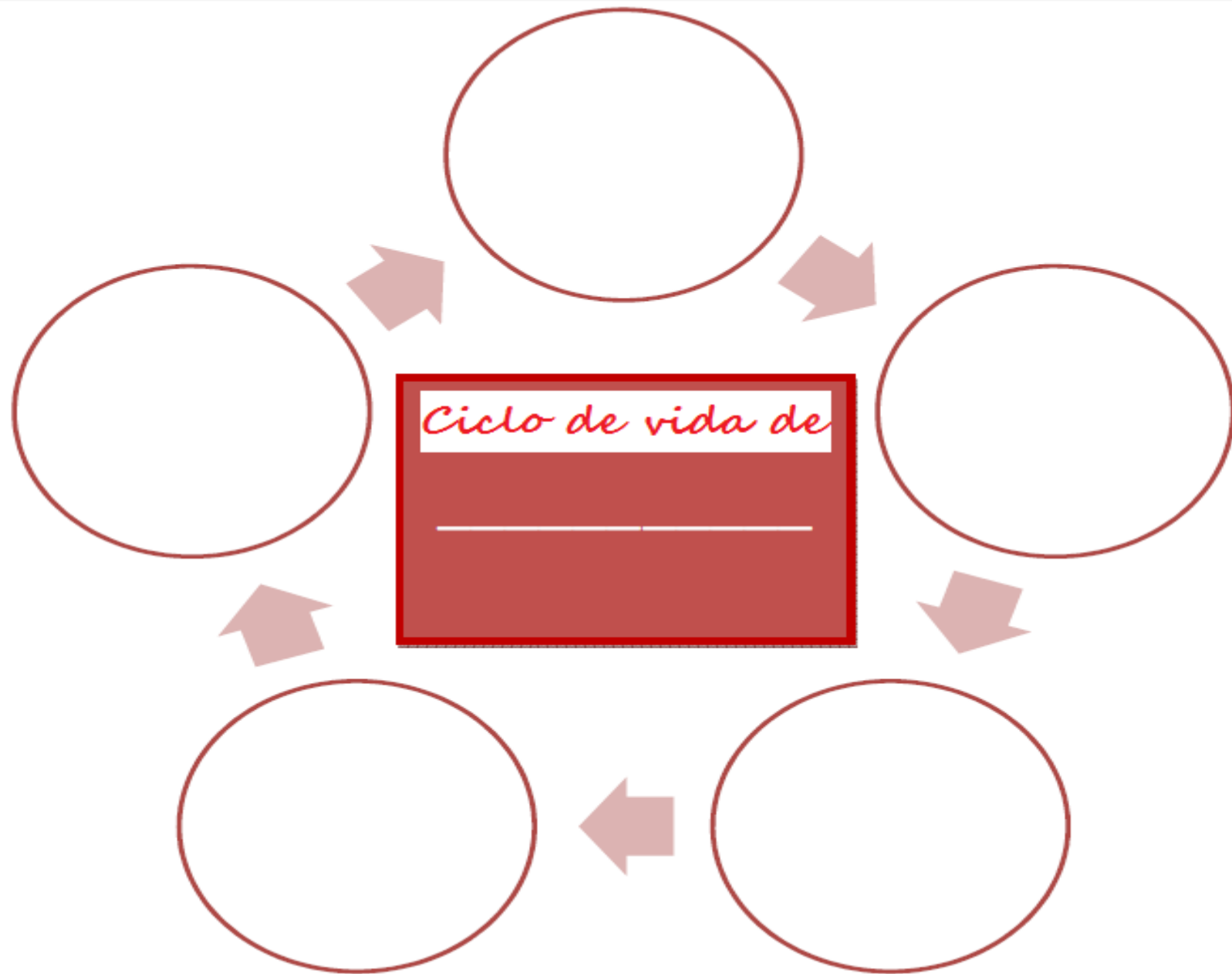

How to Fold a Mini Book (Eric Ode - www.ericode.com)

1. Fold the paper in its hot dog direction. Open it again.
2. Fold the paper in its hamburger direction. Leave it folded.
- 3a. Fold each side of the hamburger bun back toward the spine so that you end up with an accordion folded paper. (3b.) Bring those sides back out as a hamburger bun.
4. Cut the paper from the spine of the paper until you are half way through (stop at the fold from Step 3).
- 5a. Lay the paper down like a tent. Grab with forefingers on each side of the cut (5b.) and bring the two sides down and together. Then bring all flaps together to create the pages of your book.

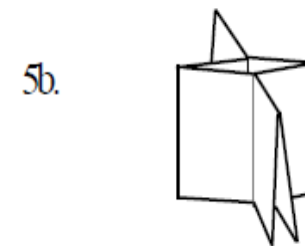
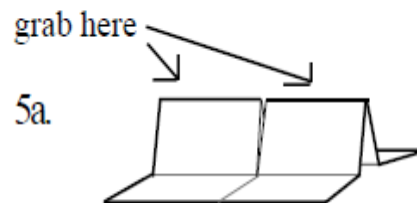
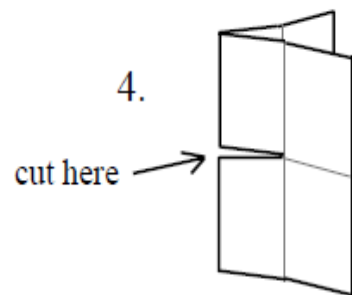
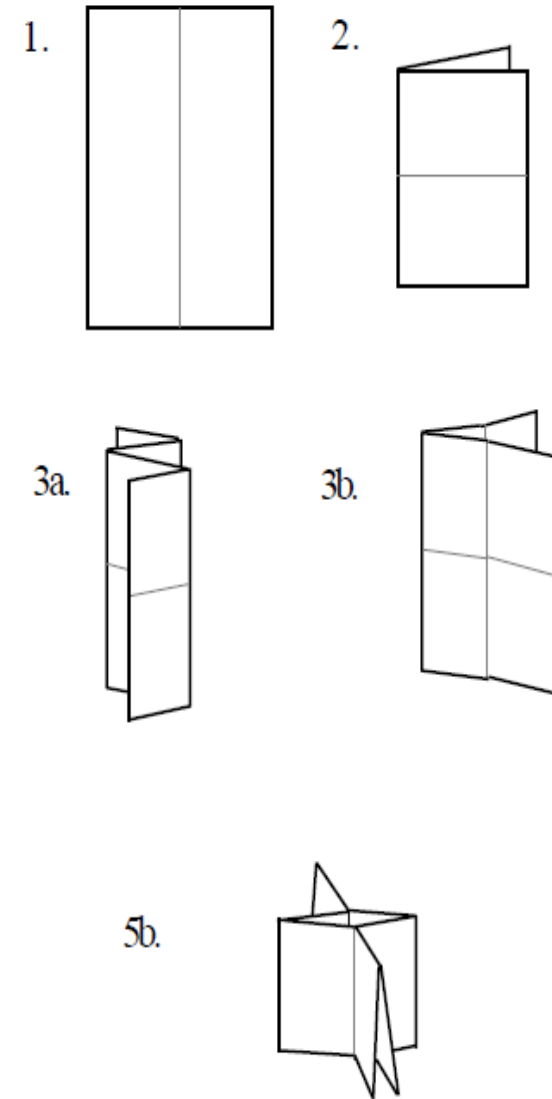

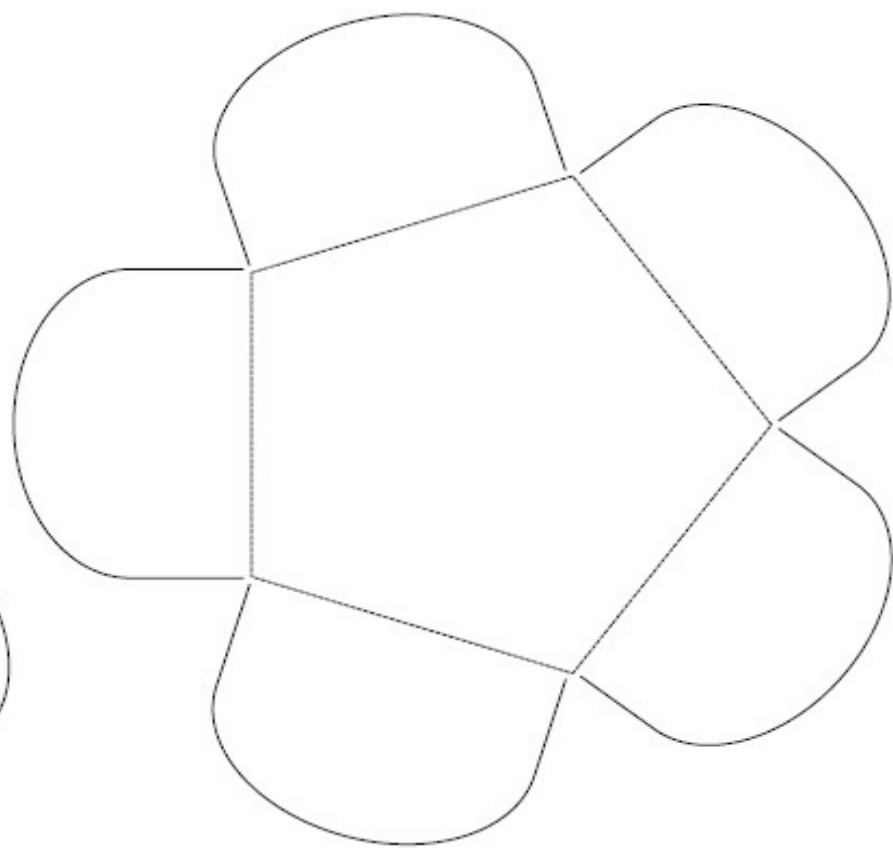
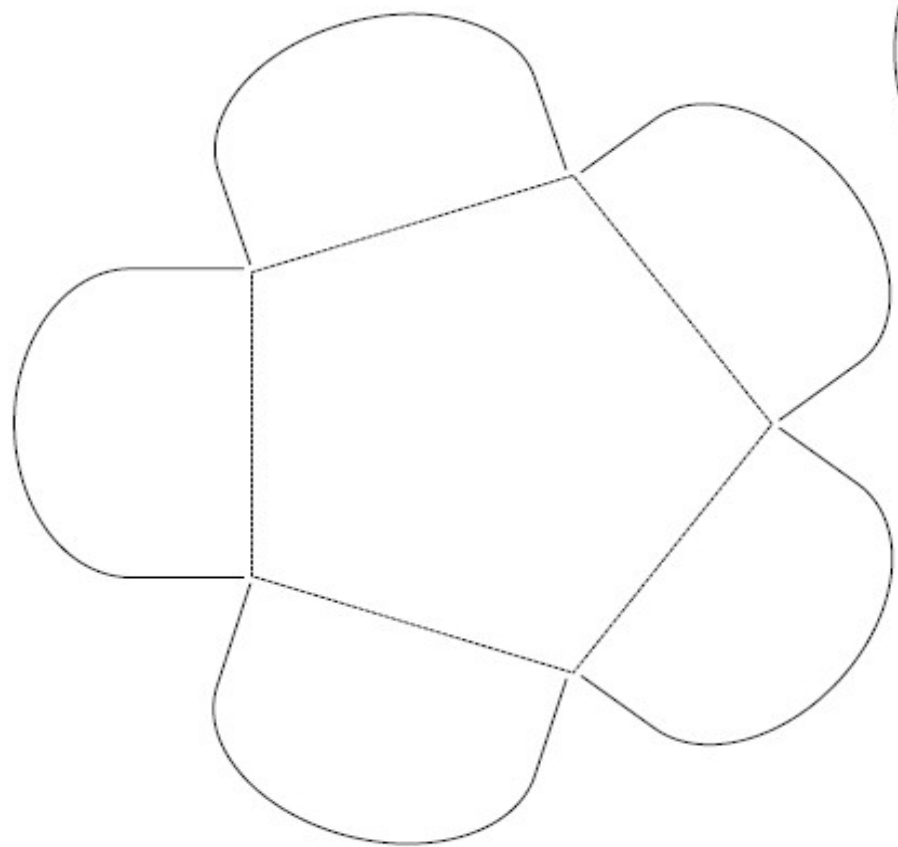

www.homeschoolshare.com

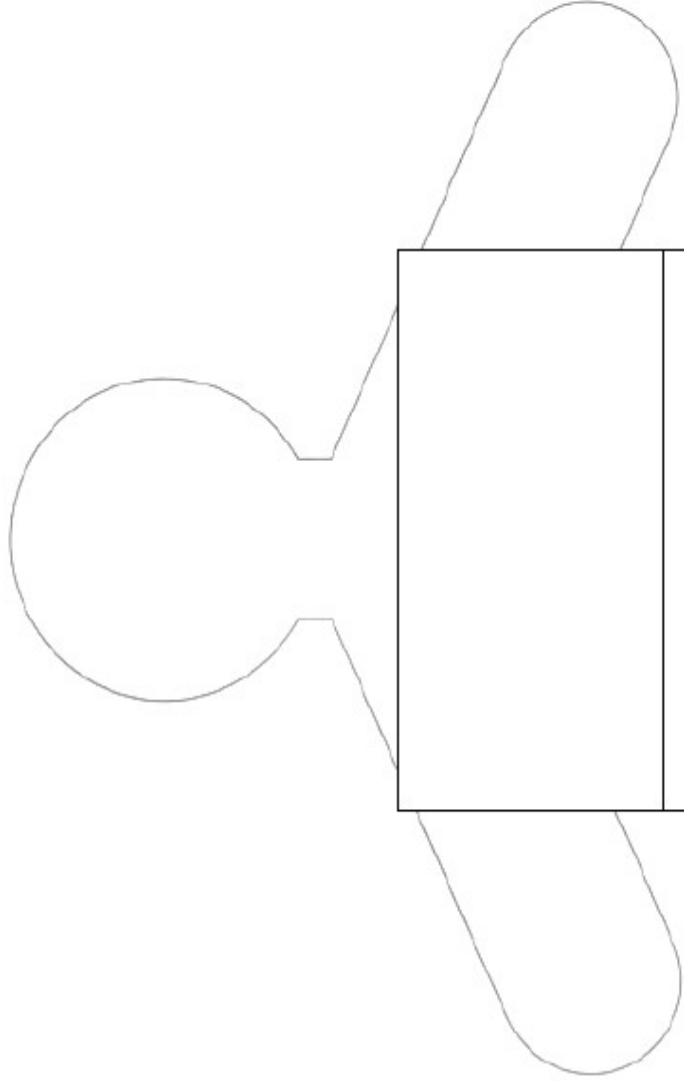

Print out and cut
around person and
pages as a whole.
Accordion fold pages so
cover is on top. Glue
back of person into
lapbook.

www.homeschoolshare.com

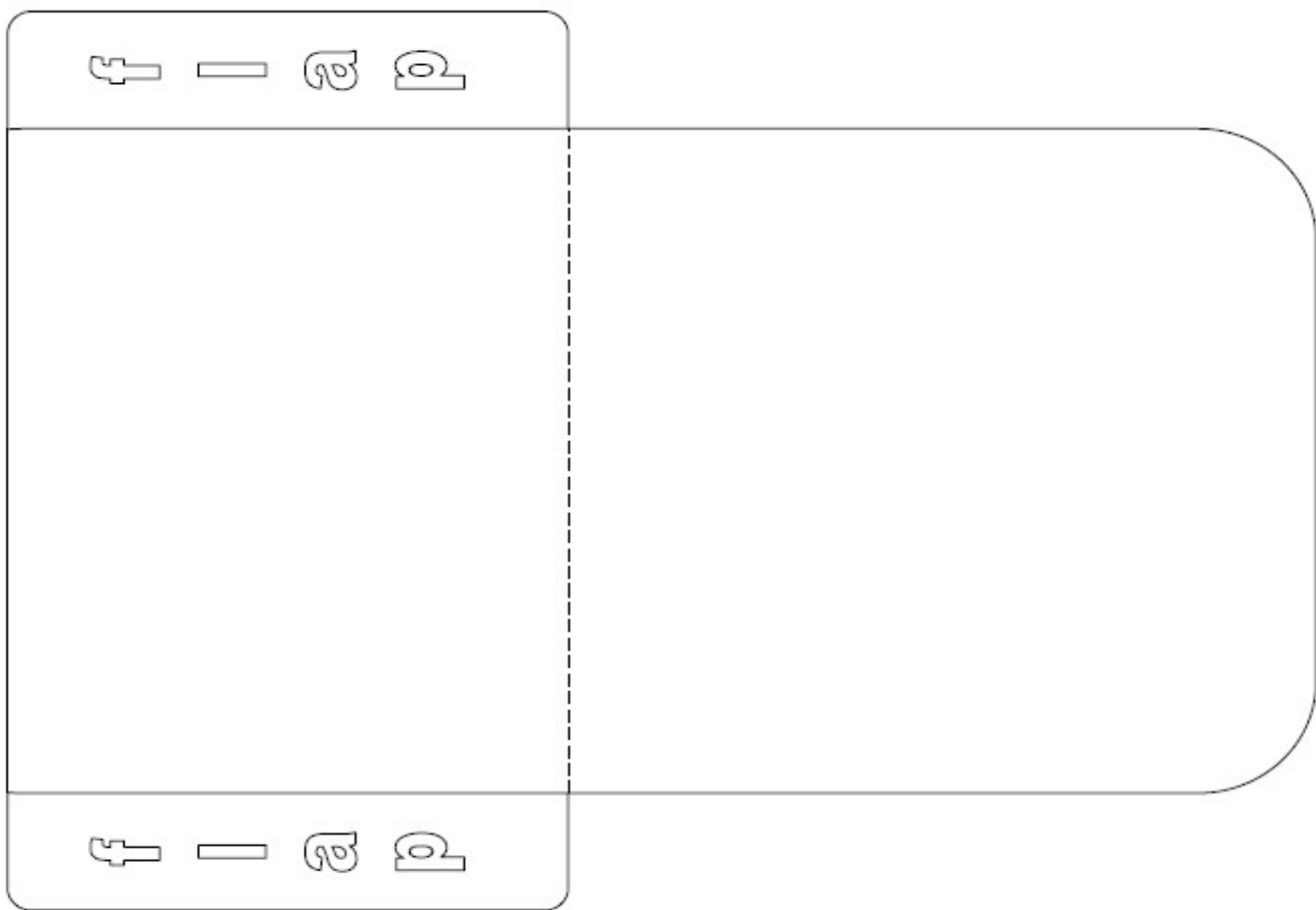

Cut both pockets out. Fold back flap up and wrap side flaps around the back and glue down.
Glue the back of your pocket into your lapbook.

www.homeschoolshare.com

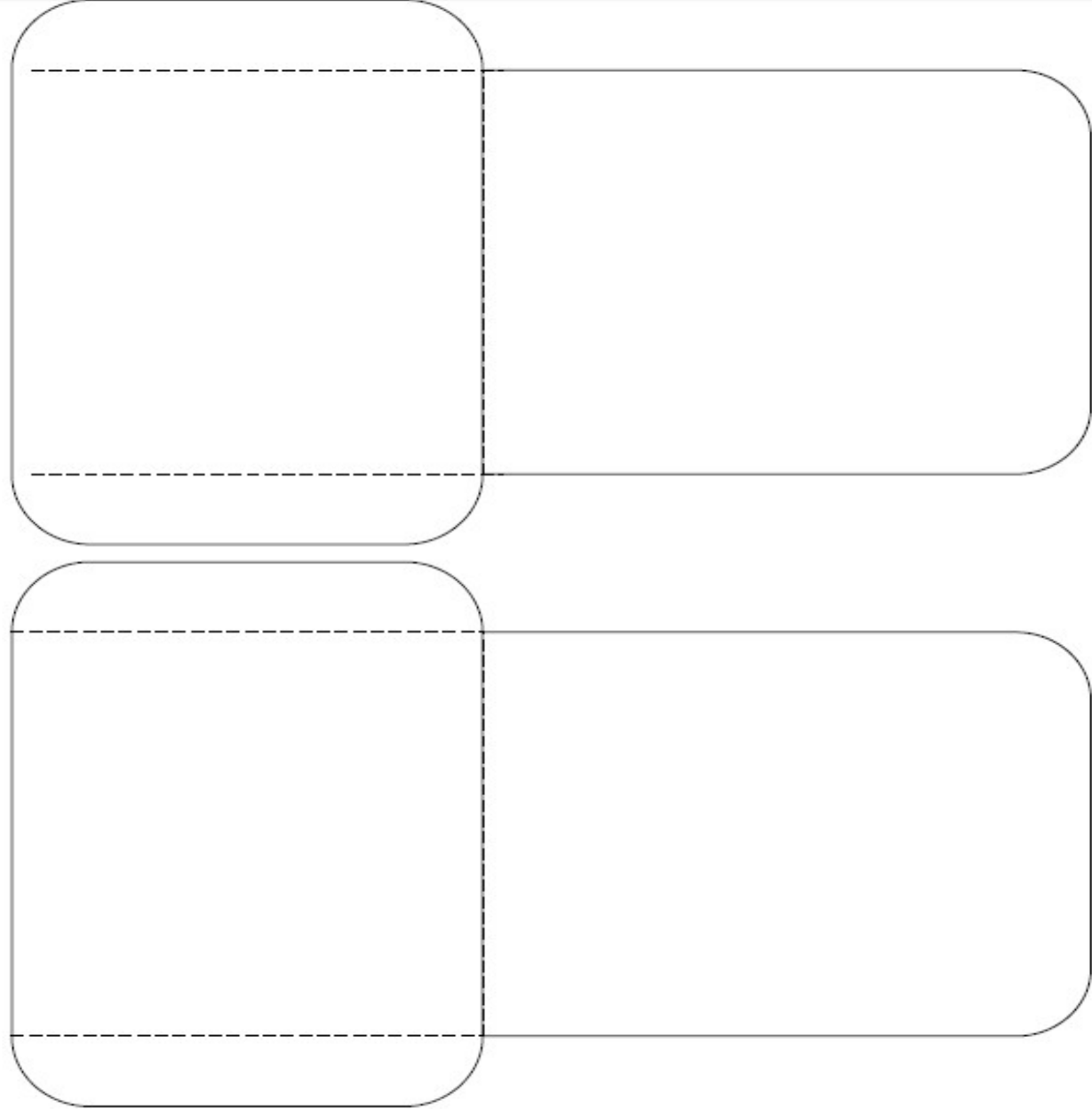

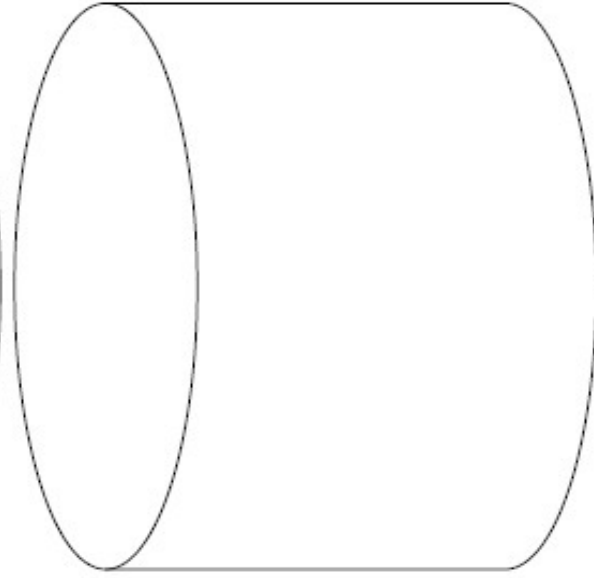
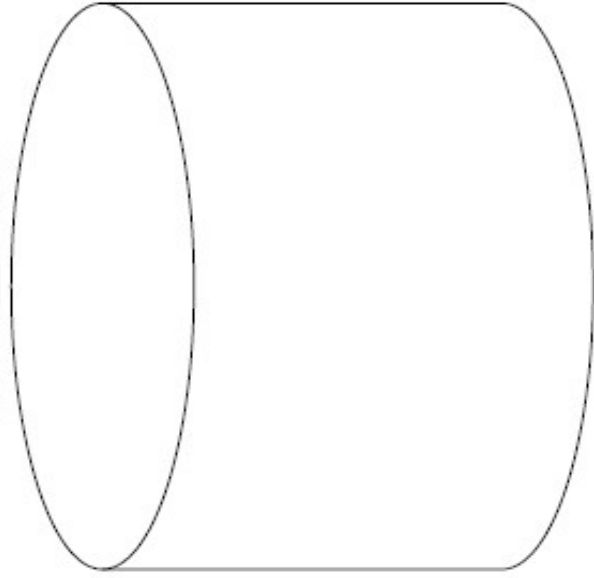
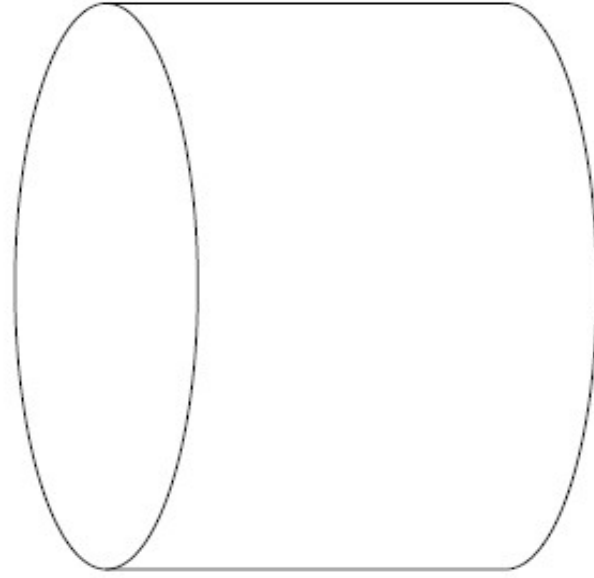
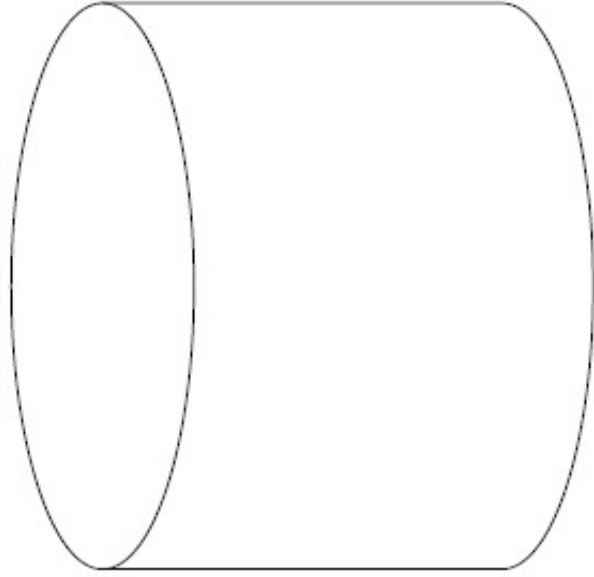
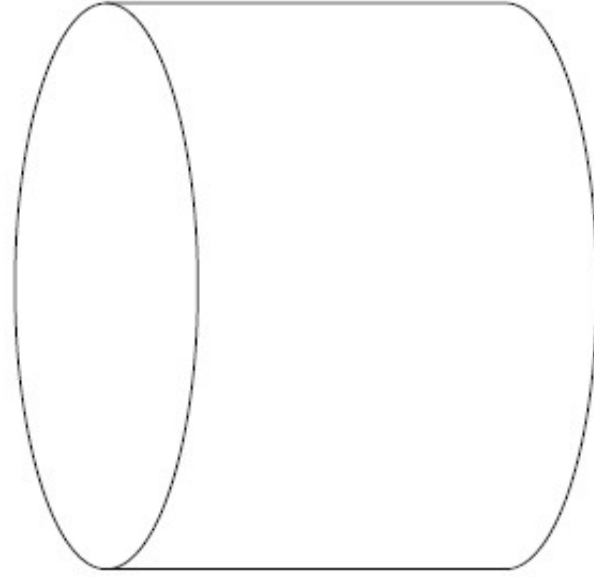

Cut out cylinder shapes. Stack together and staple on the left side to form booklet.

www.homeschoolshare.com

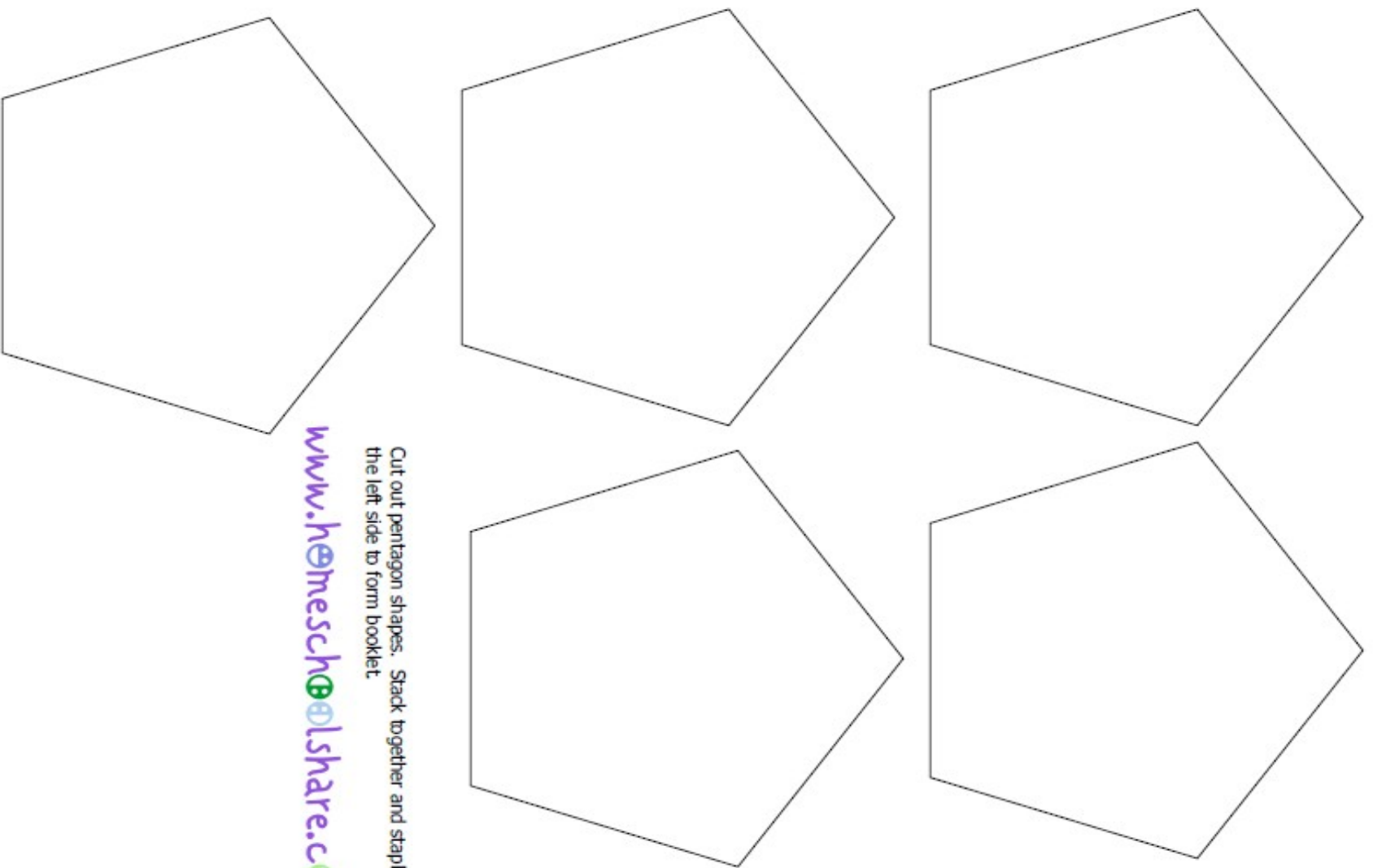

Cut out pentagon shapes. Stack together and staple on the left side to form booklet.

www.homeschoolshare.com

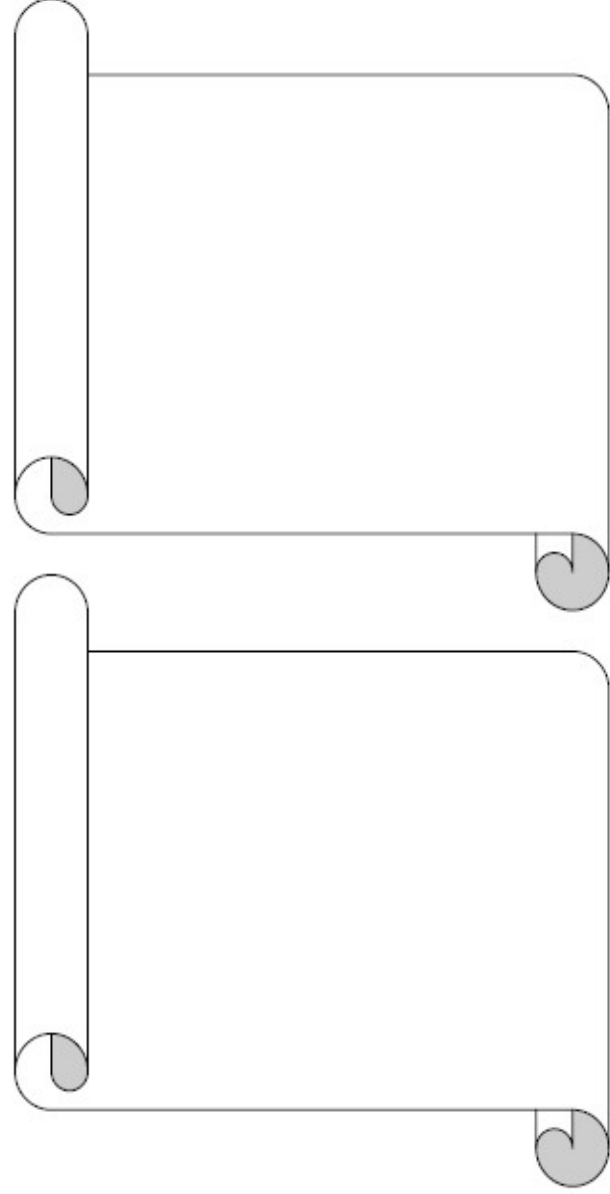
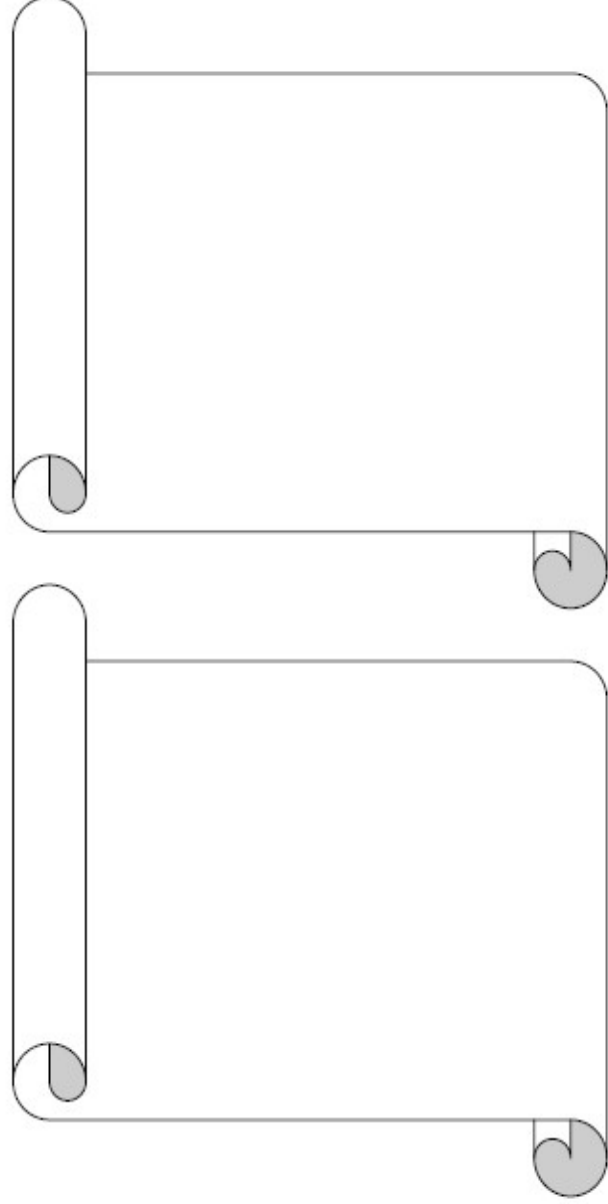

Cut out scroll shapes. Stack together and staple on the top to form booklet.

Cut out rectangle as one piece. Fold on solid lines. You should have a book that opens like the "shutters" on a window.

www.homeschoolshare.com

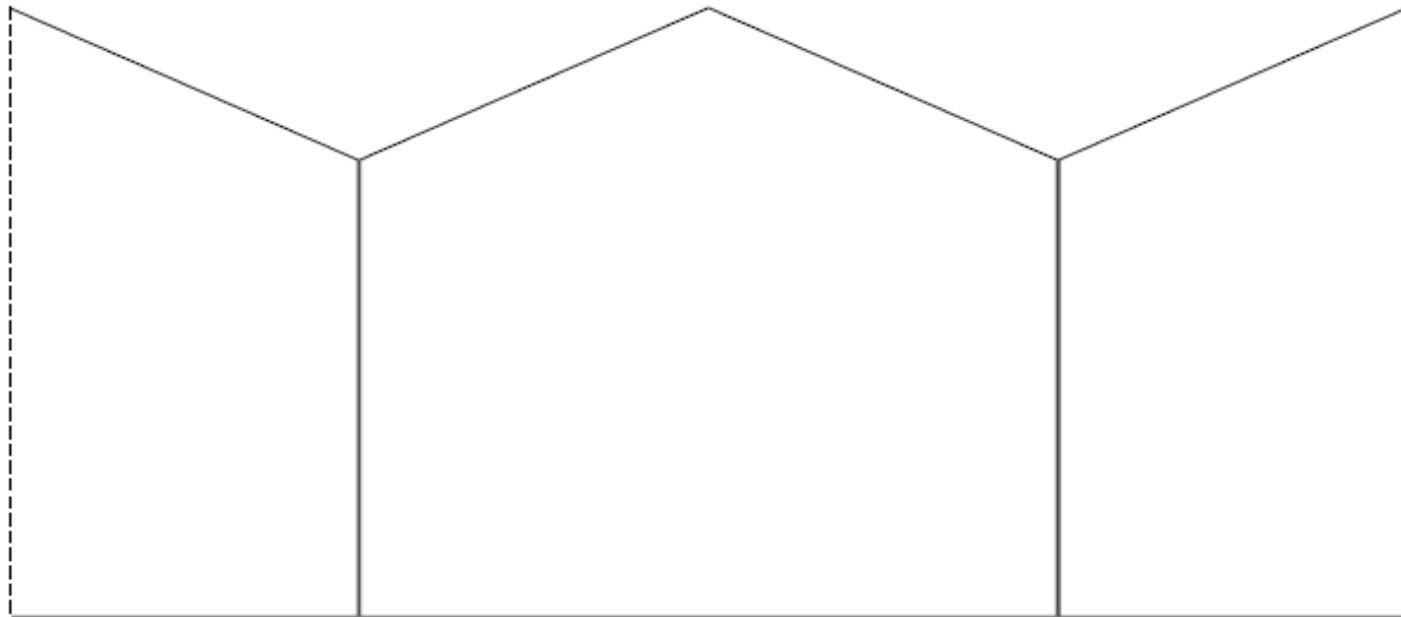

Cut books out on solid lines; fold on dotted lines.

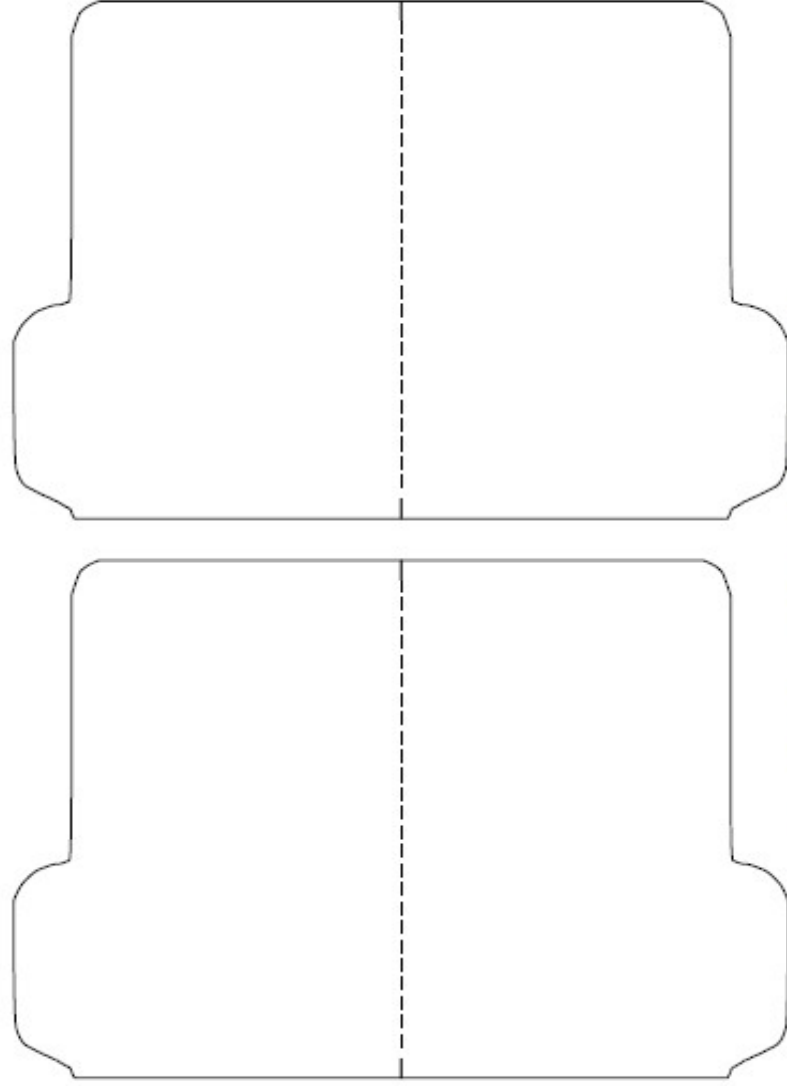

www.homeschoolshare.com

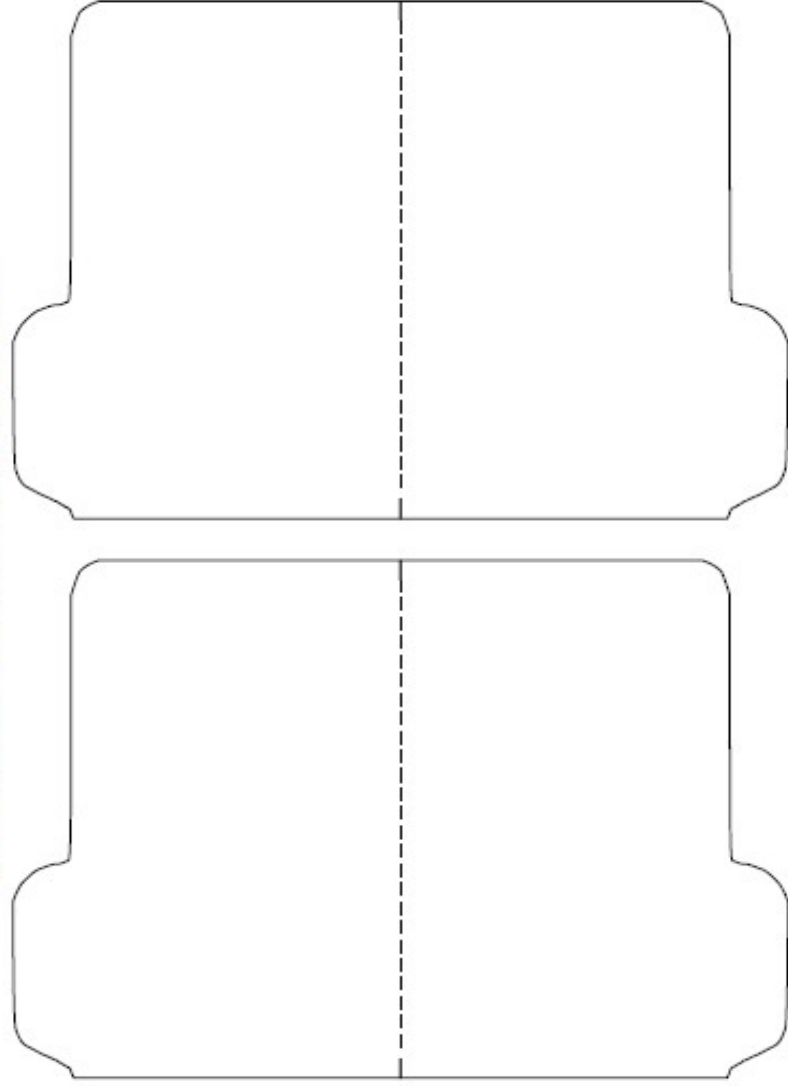

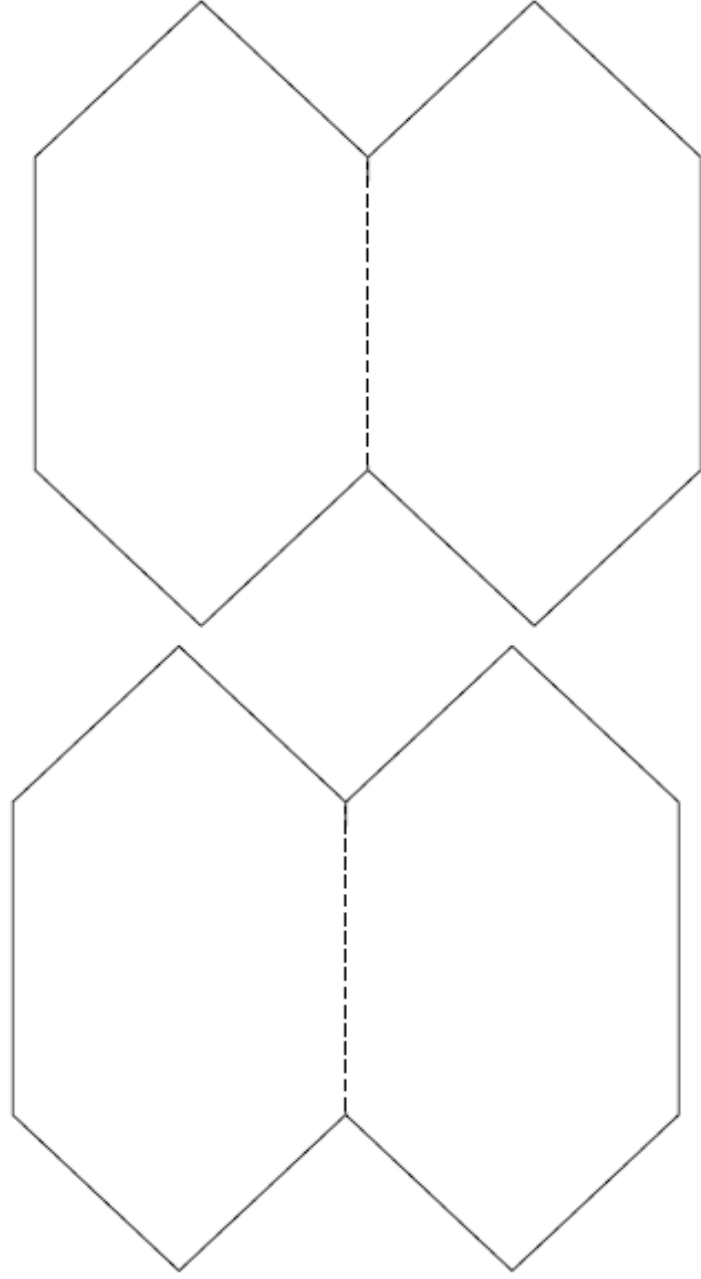

Cut books out on solid lines; fold on dotted lines.

www.homeschoolshare.com

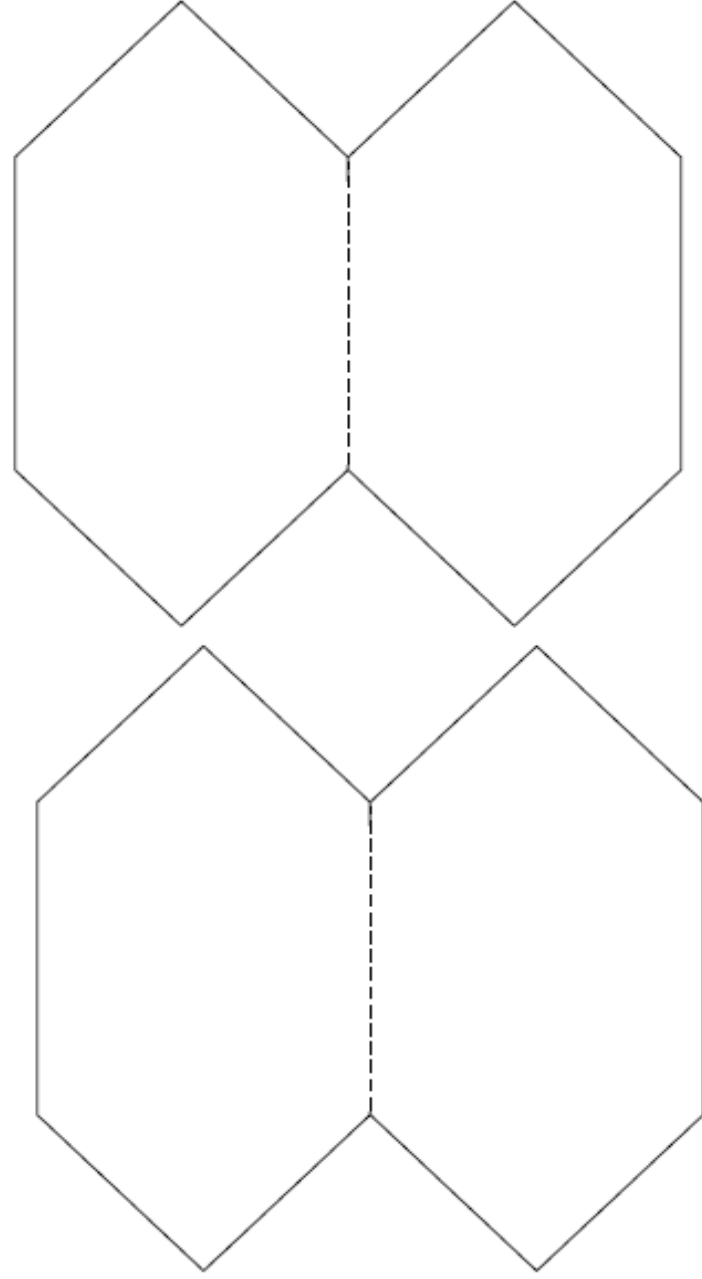

Cut books out on solid lines; fold on dotted lines.

www.homeschoolshare.com

